

## Silicon PNP Power Transistors

## 2SB553

## DESCRIPTION

- With TO-220C package
- Complement to type 2SD553
- Low collector saturation voltage

## APPLICATIONS

- High current switching applications
- Power amplifier applications

## PINNING

PIN	DESCRIPTION
1	Emitter
2	Collector;connected to mounting base
3	Base

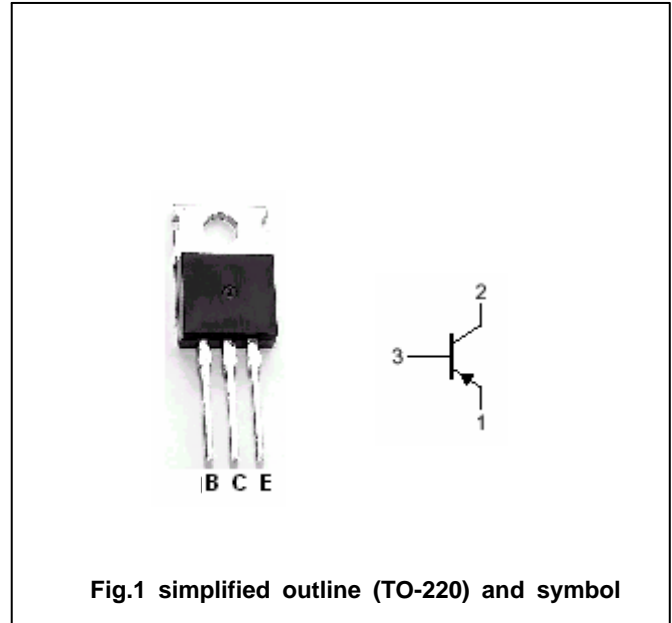
Absolute maximum ratings( $T_a=25^\circ\text{C}$ )

SYMBOL	PARAMETER	CONDITIONS	VALUE	UNIT
$V_{CBO}$	Collector-base voltage	Open emitter	-70	V
$V_{CEO}$	Collector-emitter voltage	Open base	-50	V
$V_{EBO}$	Emitter-base voltage	Open collector	-5	V
$I_C$	Collector current (DC)		-7	A
$P_C$	Collector dissipation	$T_a=25$	1.5	W
		$T_C=25$	40	
$T_j$	Junction temperature		150	
$T_{stg}$	Storage temperature		-50~150	

## Silicon PNP Power Transistors

## 2SB553

## CHARACTERISTICS

T<sub>j</sub>=25 unless otherwise specified

SYMBOL	PARAMETER	CONDITIONS	MIN	TYP.	MAX	UNIT
V <sub>(BR)CEO</sub>	Collector-emitter breakdown voltage	I <sub>C</sub> =-50mA; I <sub>B</sub> =0	-50			V
V <sub>CEsat</sub>	Collector-emitter saturation voltage	I <sub>C</sub> =-4A; I <sub>B</sub> =-0.4A		-0.2	-0.4	V
V <sub>BEsat</sub>	Base-emitter saturation voltage	I <sub>C</sub> =-4A; I <sub>B</sub> =-0.4A		-0.9	-1.2	V
I <sub>CBO</sub>	Collector cut-off current	V <sub>CB</sub> =-70V; I <sub>E</sub> =0			-30	μA
I <sub>EBO</sub>	Emitter cut-off current	V <sub>EB</sub> =-5V; I <sub>C</sub> =0			-50	μA
h <sub>FE-1</sub>	DC current gain	I <sub>C</sub> =-1A; V <sub>CE</sub> =-1V	70		240	
h <sub>FE-2</sub>	DC current gain	I <sub>C</sub> =-4A; V <sub>CE</sub> =-1V	30			
C <sub>OB</sub>	Collector output capacitance	I <sub>E</sub> =0; V <sub>CB</sub> =-10V; f=1MHz		250		pF
f <sub>T</sub>	Transition frequency	I <sub>C</sub> =-1A; V <sub>CE</sub> =-4V		10		MHz

## Switching times

t <sub>on</sub>	Turn-on time	I <sub>B1</sub> =-I <sub>B2</sub> =-0.3A; V <sub>CC</sub> =-30V R <sub>L</sub> =10		0.2		μs
t <sub>s</sub>	Storage time			2.5		μs
t <sub>f</sub>	Fall time			0.5		μs

◆ h<sub>FE-1</sub> Classifications

O	Y
70-140	120-240

Silicon PNP Power Transistors

2SB553

PACKAGE OUTLINE

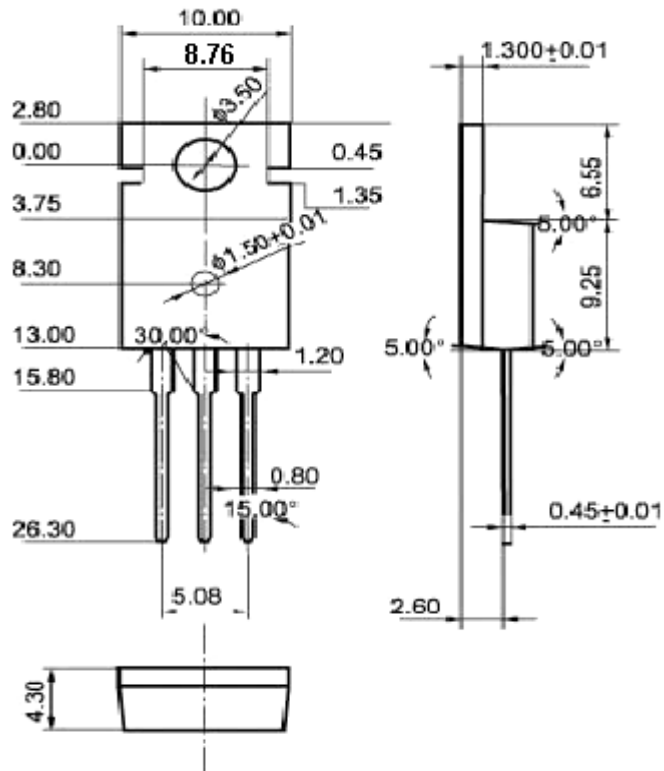

Fig.2 Outline dimensions (unindicated tolerance: ± 0.10mm)

Silicon PNP Power Transistors

2SB553

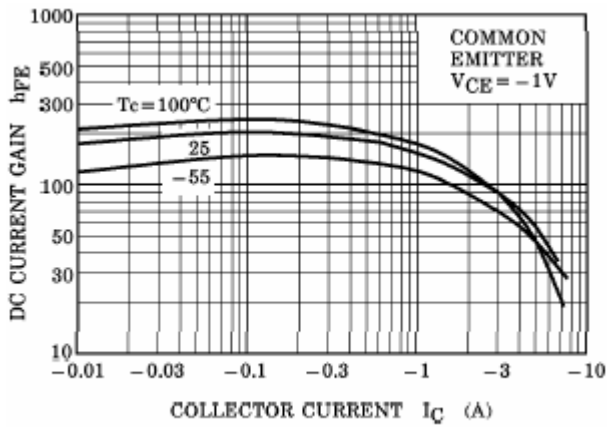

Fig.3 DC current Gain

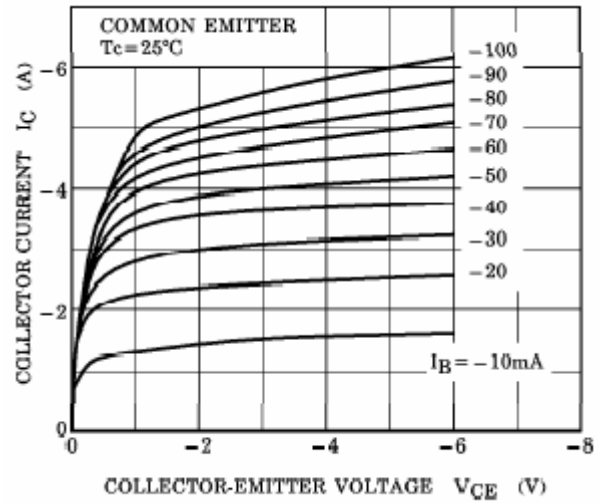

Fig.4 Static Characteristic

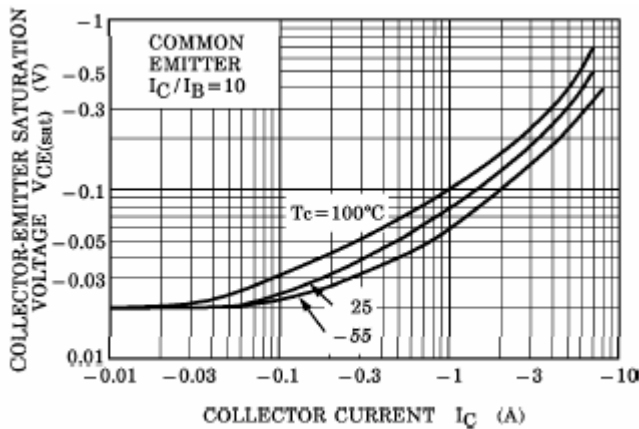

Fig.5 Collector-Emitter Saturation Voltage

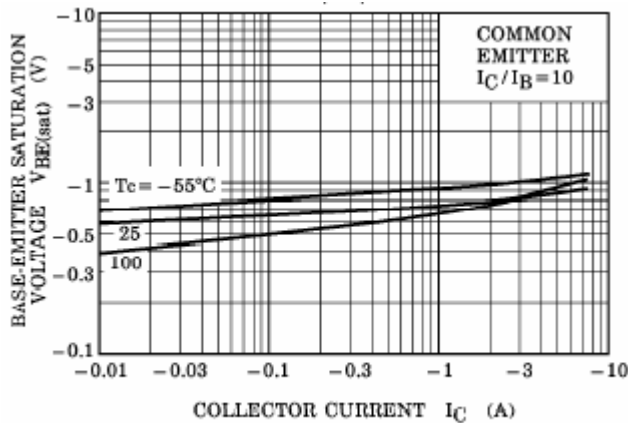

Fig.6 Base-Emitter Saturation Voltage

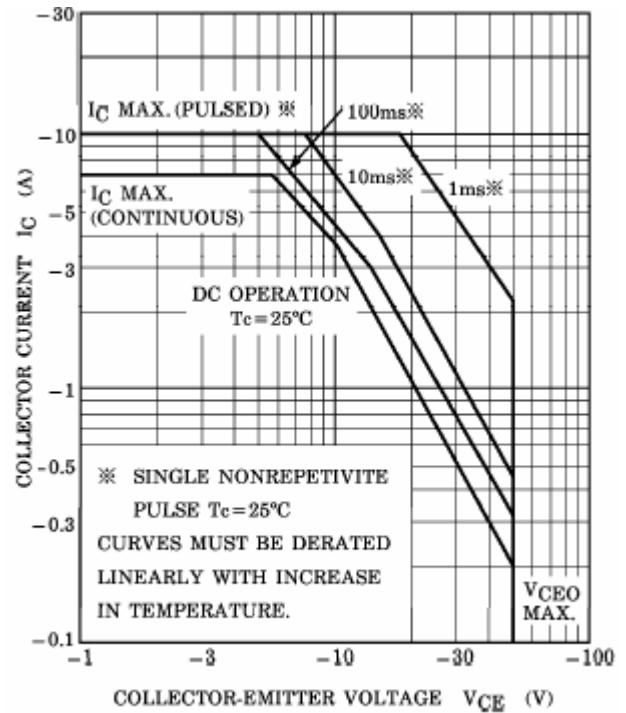

Fig.7 Safe Operating Area