

Silicon NPN Power Transistors

2SC3149

DESCRIPTION

- With TO-220C package
- High breakdown voltage:
 $V_{CBO}=900V(\text{Min})$
- Fast switching speed.
- Wide ASO (Safe Operating Area)

APPLICATIONS

- 800V/1.5A switching regulator applications

PINNING

PIN	DESCRIPTION
1	Base
2	Collector;connected to mounting base
3	Emitter

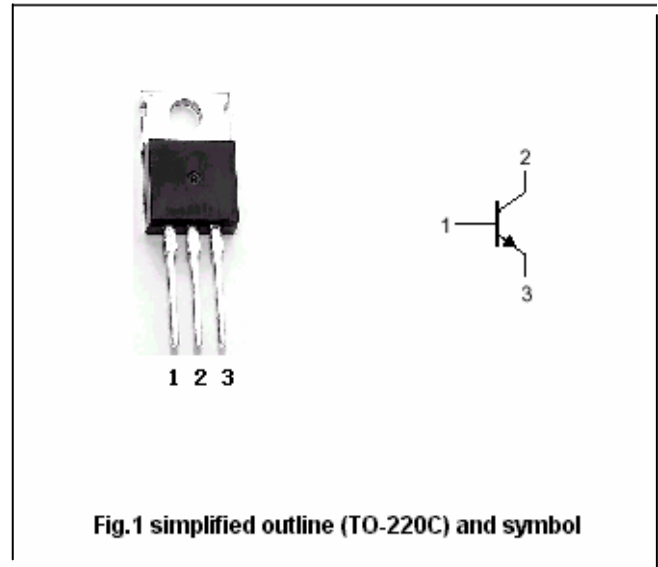

Absolute maximum ratings($T_a=25^\circ\text{C}$)

SYMBOL	PARAMETER	CONDITIONS	VALUE	UNIT
V_{CBO}	Collector-base voltage	Open emitter	900	V
V_{CEO}	Collector-emitter voltage	Open base	800	V
V_{EBO}	Emitter-base voltage	Open collector	7	V
I_C	Collector current		1.5	A
I_{CM}	Collector current-peak		5	A
I_B	Base current		0.8	A
P_C	Collector dissipation	$T_C=25$	40	W
T_j	Junction temperature		150	
T_{stg}	Storage temperature		-55~150	

Silicon NPN Power Transistors

2SC3149

CHARACTERISTICS

T_j=25 unless otherwise specified

SYMBOL	PARAMETER	CONDITIONS	MIN	TYP.	MAX	UNIT
V _{(BR)CEO}	Collector-emitter breakdown voltage	I _C =5mA ; R _{BE} =	800			V
V _{(BR)CBO}	Collector-base breakdown voltage	I _C =1mA ; I _E =0	900			V
V _{(BR)EBO}	Emitter-base breakdown voltage	I _E =1mA ; I _B =0	7			V
V _{CEsat}	Collector-emitter saturation voltage	I _C =0.75A ; I _B =0.15A			2.0	V
V _{BEsat}	Base-emitter saturation voltage	I _C =0.75A ; I _B =0.15A			1.5	V
I _{CBO}	Collector cut-off current	V _{CB} =800V ; I _E =0			10	μA
I _{EBO}	Emitter cut-off current	V _{EB} =5V ; I _C =0			10	μA
h _{FE-1}	DC current gain	I _C =0.1A ; V _{CE} =5V	10		40	
h _{FE-2}	DC current gain	I _C =0.5A ; V _{CE} =5V	8			
f _T	Transition frequency	I _C =0.1A ; V _{CE} =10V		15		MHz
C _{OB}	Output capacitance	f=10MHz ; V _{CB} =10V		30		pF

Switching times

t _{on}	Turn-on time	V _{CC} =400V ; I _C =1A I _{B1} =0.2A ; I _{B2} =-0.4A ; R _L =400			1.0	μs
t _{stg}	Storage time				3.0	μs
t _f	Fall time				0.7	μs

◆ h_{FE-1} classifications

K	L	M
10-20	15-30	20-40

Silicon NPN Power Transistors

2SC3149

PACKAGE OUTLINE

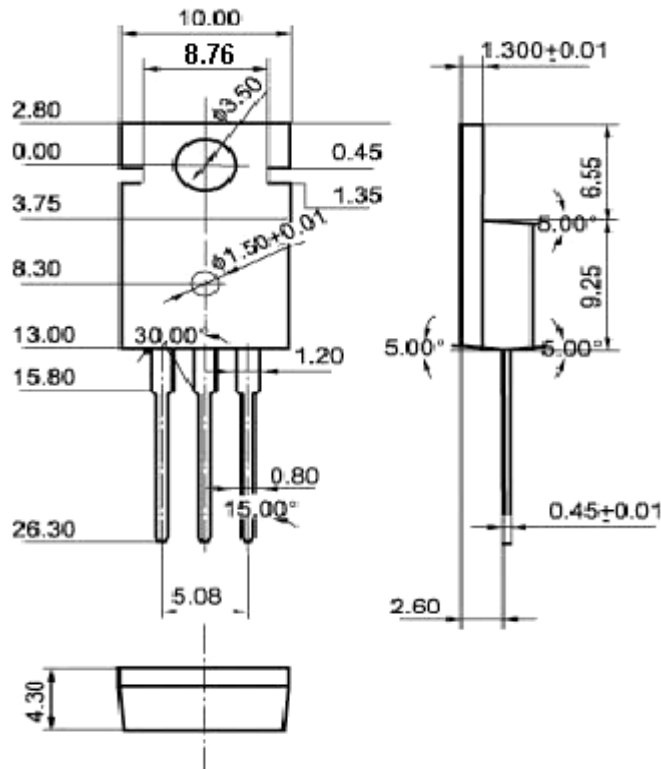

Fig.2 Outline dimensions (unindicated tolerance: ± 0.10 mm)

Silicon NPN Power Transistors

2SC3149

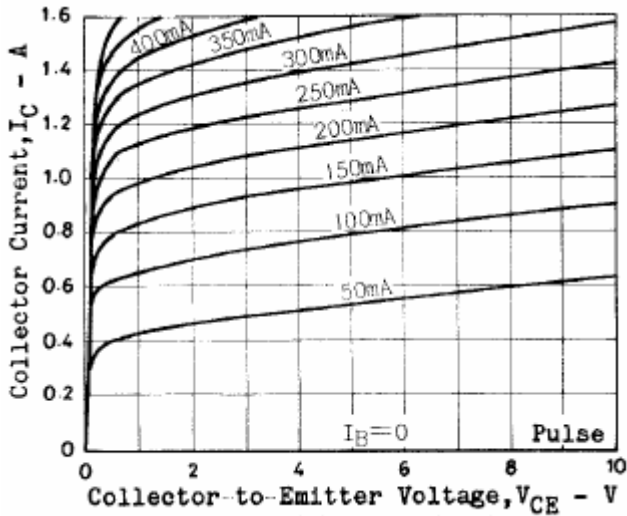

Fig.3 Static Characteristic

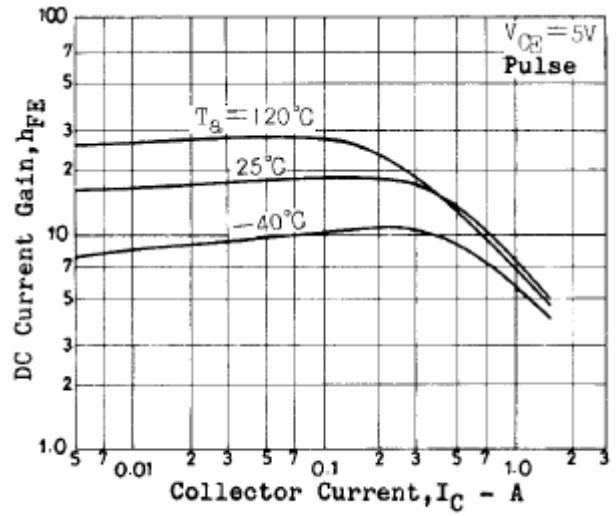

Fig.4 DC current Gain

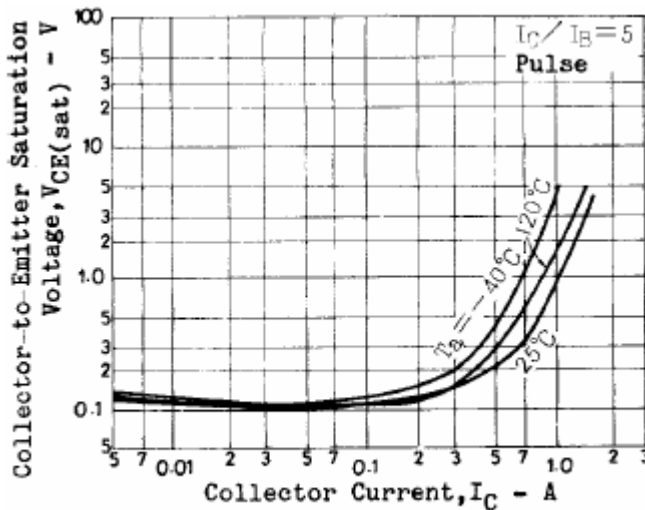

Fig.5 Collector-Emitter Saturation Voltage

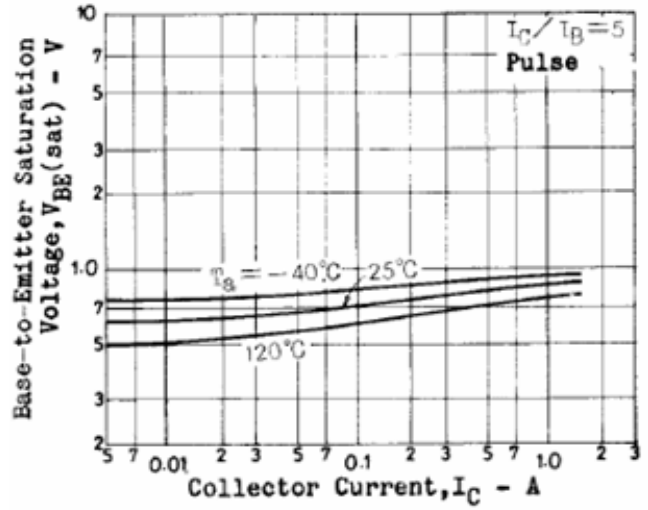

Fig.6 Base-Emitter Saturation Voltage

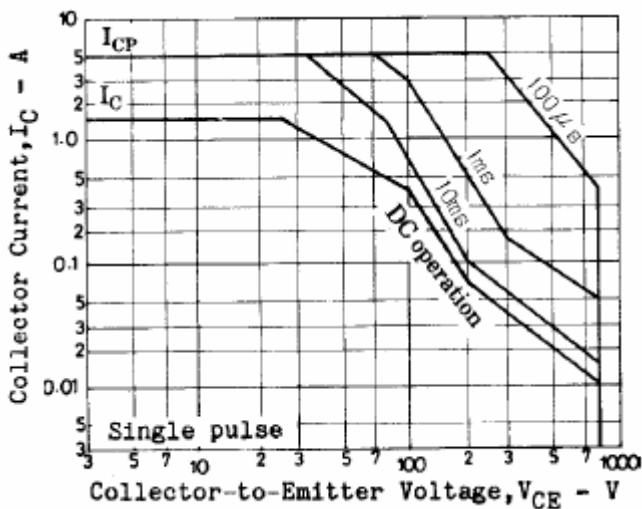

Fig.7 Safe Operating Area