

Silicon NPN Power Transistors

2SC3152

DESCRIPTION

- With TO-3PN package
- High breakdown voltage ($V_{CBO} = 900V$)
- Fast switching speed
- Wide ASO (Safe Operating Area)

APPLICATIONS

- 800V/3A Switching Regulator Applications

PINNING

PIN	DESCRIPTION
1	Base
2	Collector;connected to mounting base
3	Emitter

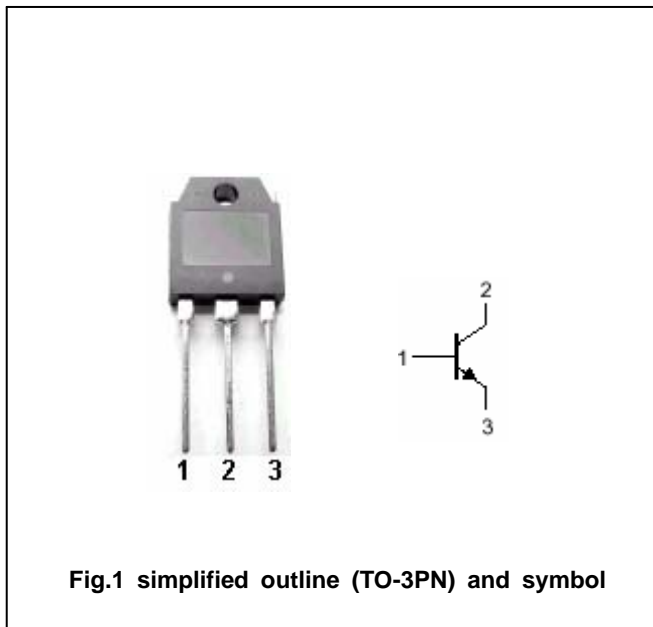

Fig.1 simplified outline (TO-3PN) and symbol

Absolute maximum ratings (Ta=25)

SYMBOL	PARAMETER	CONDITIONS	VALUE	UNIT
V_{CBO}	Collector-base voltage	Open emitter	900	V
V_{CEO}	Collector-emitter voltage	Open base	800	V
V_{EBO}	Emitter-base voltage	Open collector	7	V
I_C	Collector current		3	A
I_{CM}	Collector current-peak		10	A
I_B	Base current		1.5	A
P_C	Collector power dissipation	$T_C=25$	80	W
T_j	Junction temperature		150	
T_{stg}	Storage temperature		-55~150	

Silicon NPN Power Transistors

2SC3152

CHARACTERISTICS

T_j=25 unless otherwise specified

SYMBOL	PARAMETER	CONDITIONS	MIN	TYP.	MAX	UNIT
V _{(BR)CEO}	Collector-emitter breakdown voltage	I _C =5mA ; R _{BE} =	800			V
V _{(BR)CBO}	Collector-base breakdown voltage	I _C =1mA ; I _E =0	900			V
V _{(BR)EBO}	Emitter-base breakdown voltage	I _E =1mA ; I _C =0	7			V
V _{CEsat}	Collector-emitter saturation voltage	I _C =1.5A ; I _B =0.3A			2.0	V
V _{BEsat}	Base-emitter saturation voltage	I _C =1.5A ; I _B =0.3A			1.5	V
I _{CBO}	Collector cut-off current	V _{CB} =800V ; I _E =0			10	μA
I _{EBO}	Emitter cut-off current	V _{EB} =5V ; I _C =0			10	μA
h _{FE-1}	DC current gain	I _C =0.2A ; V _{CE} =5V	10		40	
h _{FE-2}	DC current gain	I _C =1A ; V _{CE} =5V	8			
C _{OB}	Output capacitance	I _E =0 ; V _{CB} =10V ; f=1MHz		60		pF
f _T	Transition frequency	I _C =0.2A ; V _{CE} =10V		15		MHz

Switching times

t _{on}	Turn-on time	I _C =2A ; I _{B1} =0.4A ; I _{B2} =-0.8A R _L =20 Ω , V _{CC} =400V			1.0	μs
t _s	Storage time				3.0	μs
t _f	Fall time				0.7	μs

◆ h_{FE-1} classifications

K	L	M
10-20	15-30	20-40

Silicon NPN Power Transistors

2SC3152

PACKAGE OUTLINE

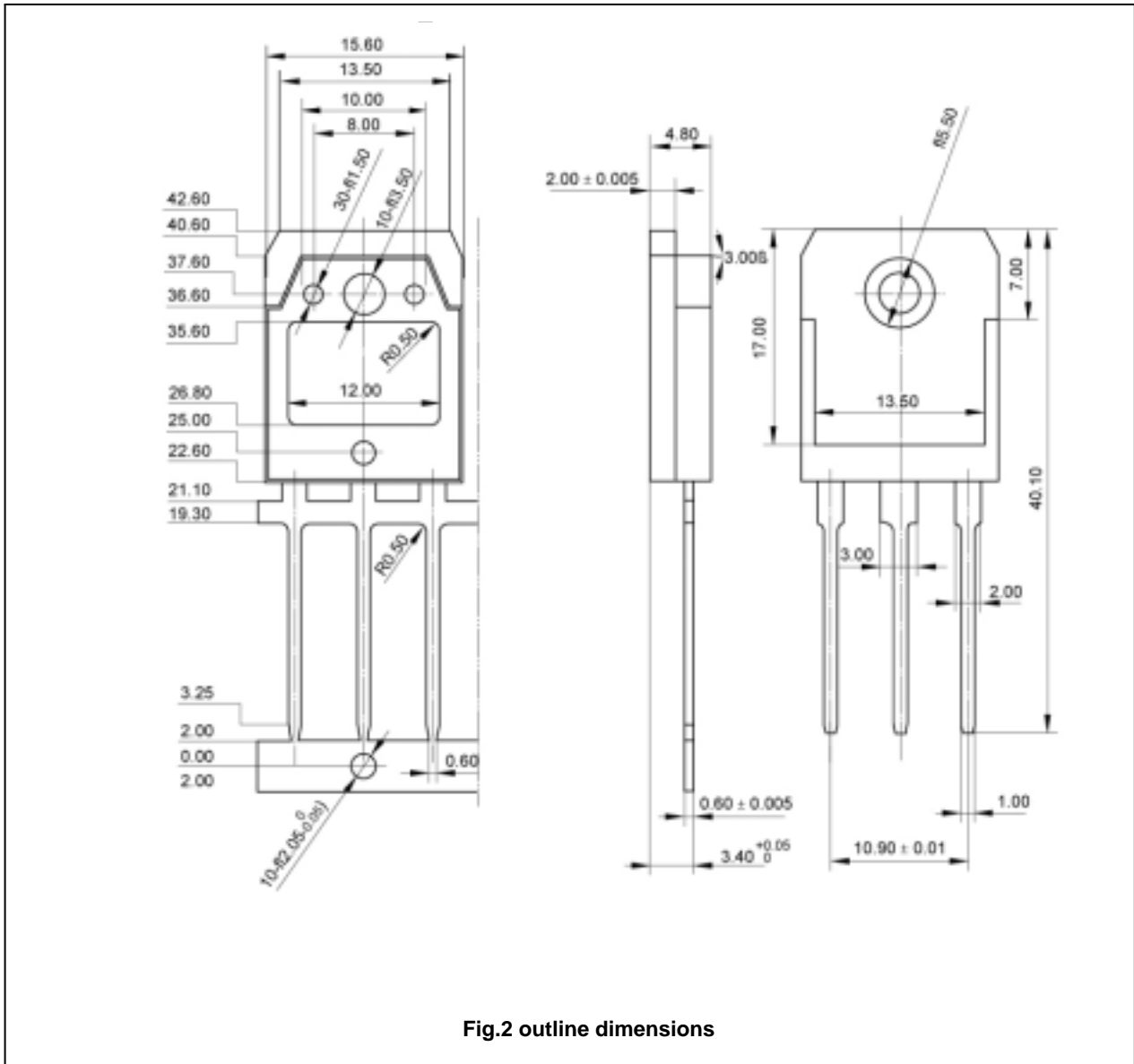

Fig.2 outline dimensions

Silicon NPN Power Transistors

2SC3152

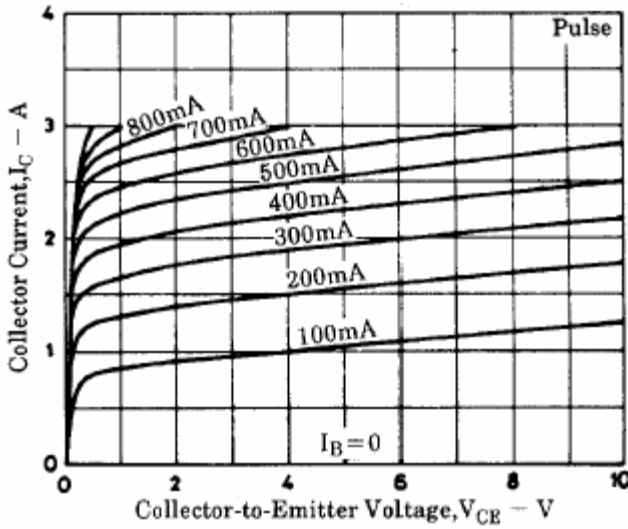

Fig.3 Static Characteristic

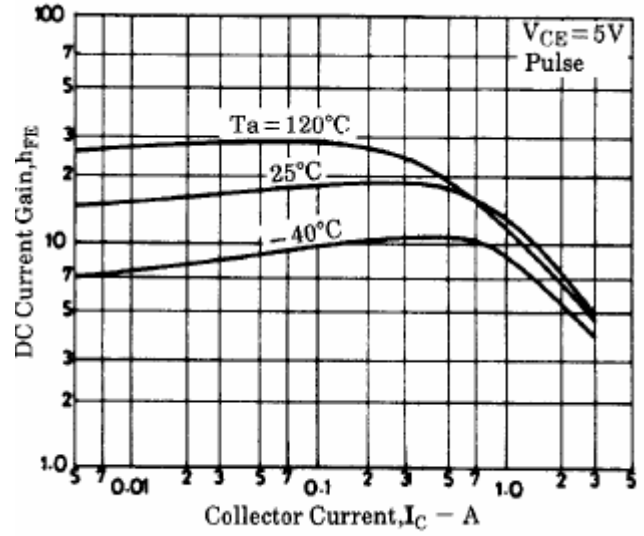

Fig.4 DC current Gain

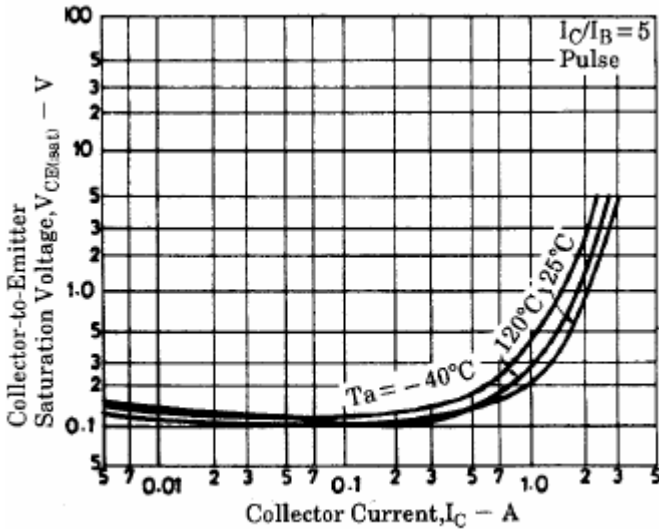

Fig.5 Collector-Emmitter Saturation Voltage

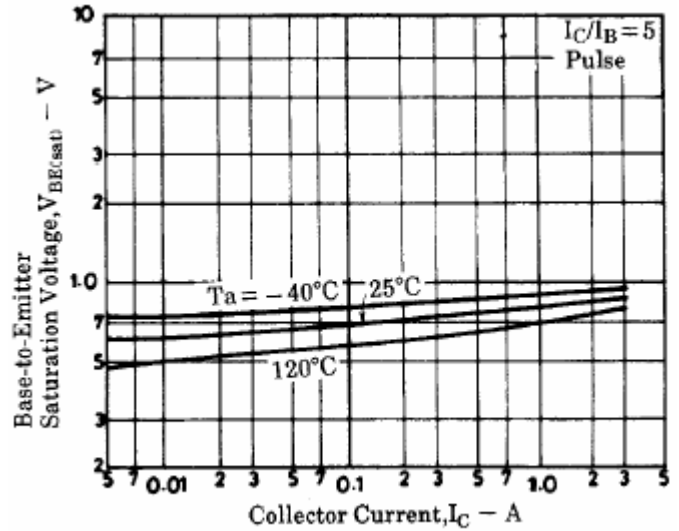

Fig.6 Base-Emmitter Saturation Voltage

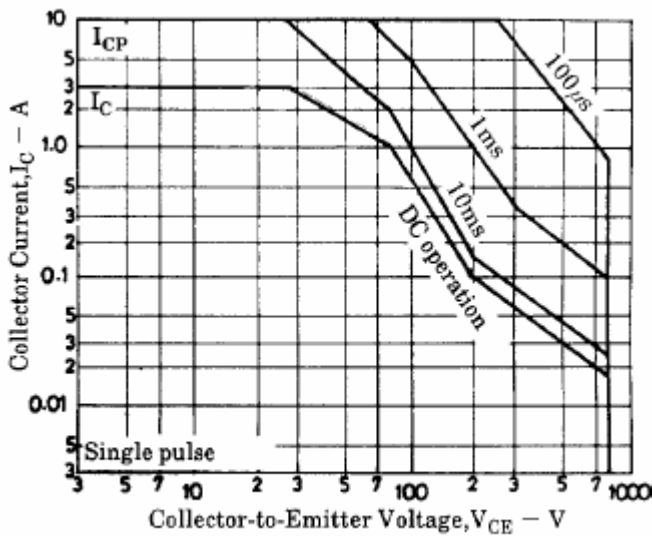

Fig.7 Safe Operating Area