

**Silicon NPN Power Transistors**

**2SC3507**

**DESCRIPTION**

- With TO-3PFa package
- High-speed switching
- High collector-base voltage  $V_{CBO}$
- Satisfactory linearity of forward current transfer ratio  $h_{FE}$

**APPLICATIONS**

- For high-speed switching applications

**PINNING**

PIN	DESCRIPTION
1	Base
2	Collector
3	Emitter

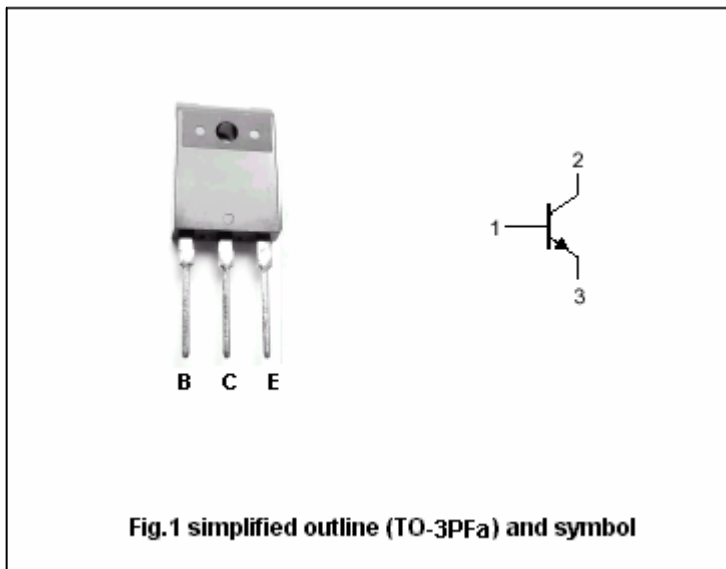

**Fig.1 simplified outline (TO-3PFa) and symbol**

**Absolute maximum ratings( $T_a=25^\circ\text{C}$ )**

SYMBOL	PARAMETER	CONDITIONS	VALUE	UNIT
$V_{CBO}$	Collector-base voltage	Open emitter	1000	V
$V_{CEO}$	Collector-emitter voltage	Open base	800	V
$V_{EBO}$	Emitter-base voltage	Open collector	7	V
$I_C$	Collector current		5	A
$I_{CM}$	Collector current-peak		10	A
$I_B$	Base current		3	A
$P_C$	Collector power dissipation	$T_C=25$	80	W
		$T_a=25$	3	
$T_j$	Junction temperature		150	
$T_{stg}$	Storage temperature		-55~150	

## Silicon NPN Power Transistors

## 2SC3507

## CHARACTERISTICS

T<sub>j</sub>=25 unless otherwise specified

SYMBOL	PARAMETER	CONDITIONS	MIN	TYP.	MAX	UNIT
V <sub>CEO(SUS)</sub>	Collector-emitter sustaining voltage	I <sub>C</sub> =0.5A ; L=50mH	800			V
V <sub>CEsat</sub>	Collector-emitter saturation voltage	I <sub>C</sub> =3A ; I <sub>B</sub> =0.6A			1.5	V
V <sub>BEsat</sub>	Base-emitter saturation voltage	I <sub>C</sub> =3A ; I <sub>B</sub> =0.6A			1.5	V
I <sub>CBO</sub>	Collector cut-off current	V <sub>CB</sub> =1000V; I <sub>E</sub> =0			50	μA
I <sub>EBO</sub>	Emitter cut-off current	V <sub>EB</sub> =7V; I <sub>C</sub> =0			50	μA
h <sub>FE</sub>	DC current gain	I <sub>C</sub> =3A ; V <sub>CE</sub> =5V	6			
f <sub>T</sub>	Transition frequency	I <sub>C</sub> =0.5A ; V <sub>CE</sub> =5V; f=1MHz		6		MHz

## Switching times

t <sub>on</sub>	Turn-on time	I <sub>C</sub> =3A; V <sub>CC</sub> =250V I <sub>B1</sub> =0.6A , I <sub>B2</sub> =-1.2A			1.0	μs
t <sub>s</sub>	Storage time				2.5	μs
t <sub>f</sub>	Fall time				0.5	μs

Silicon NPN Power Transistors

2SC3507

PACKAGE OUTLINE

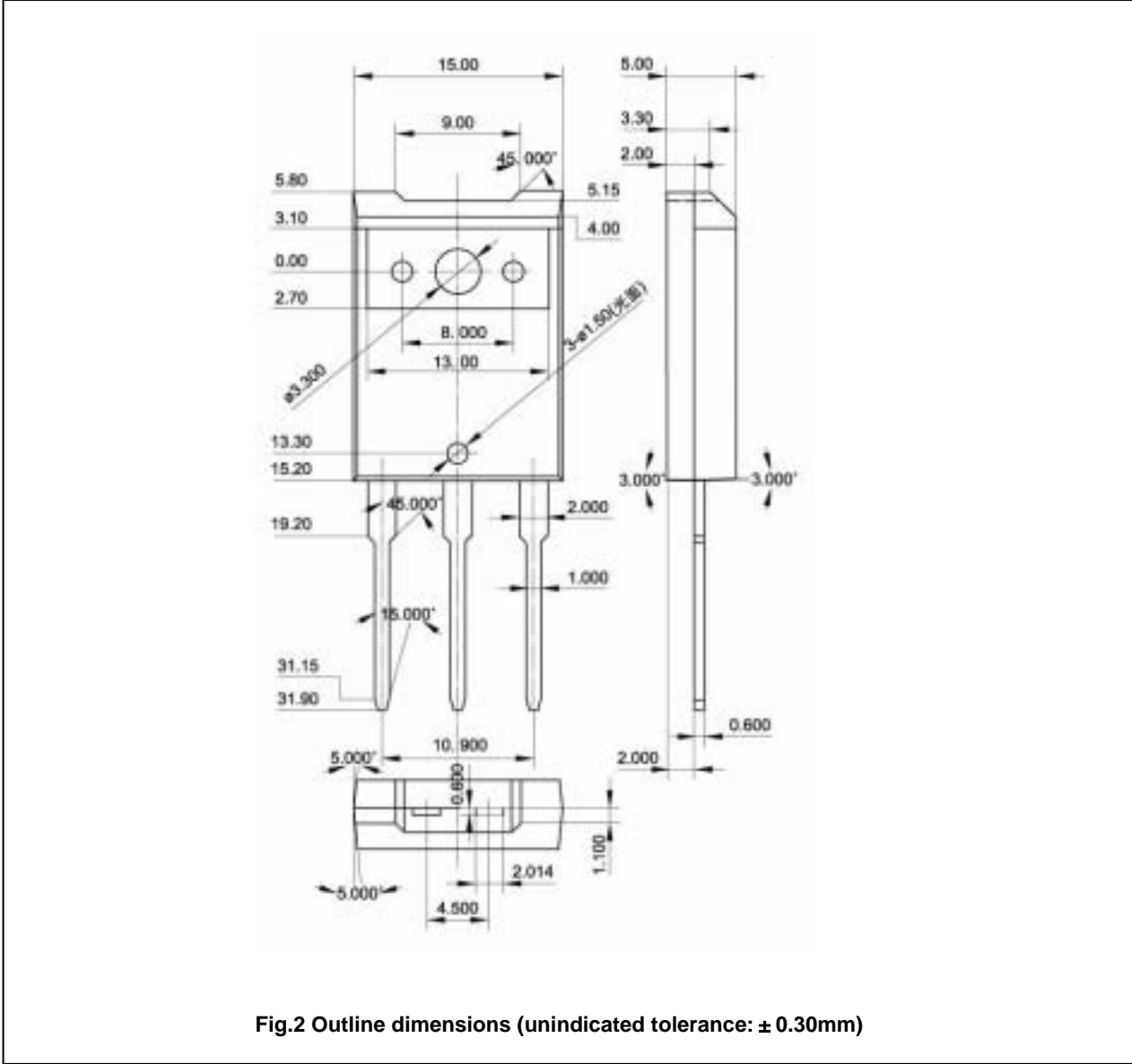

Silicon NPN Power Transistors

2SC3507

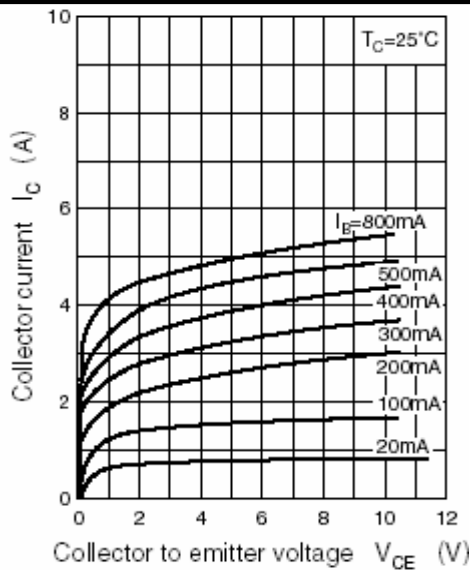

Fig.3 Static Characteristic

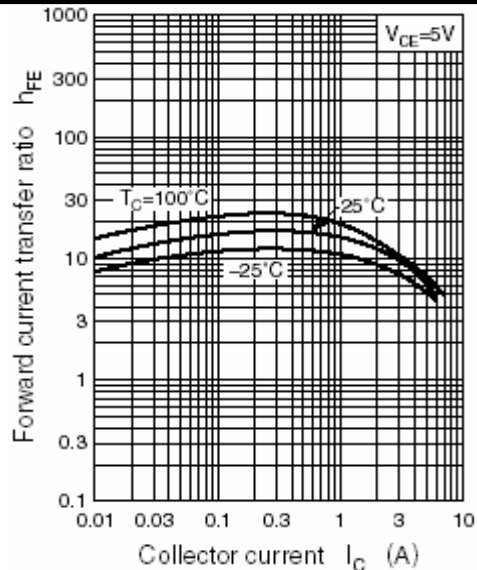

Fig.4 DC current Gain

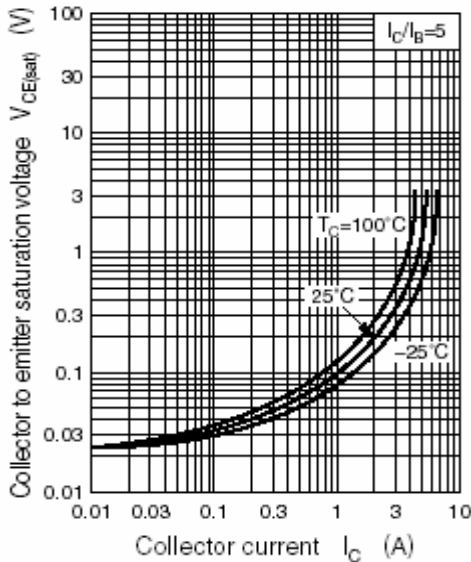

Fig.5 Collector-Emitter Saturation Voltage

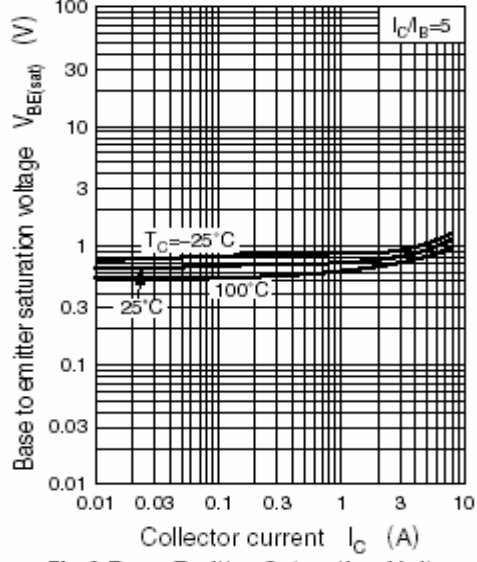

Fig.6 Base-Emitter Saturation Voltage

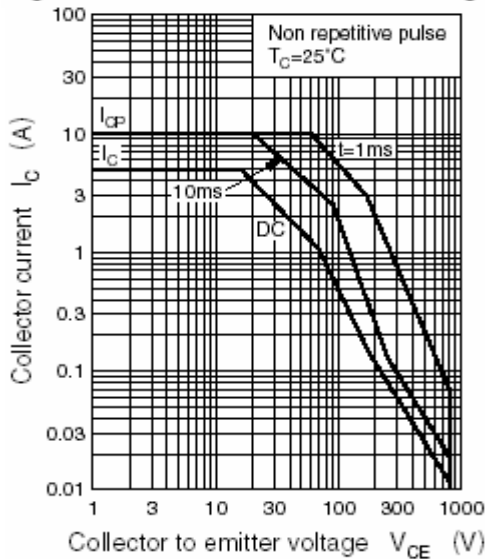

Fig.7 Safe Operating Area