

## Silicon NPN Power Transistors

2SC3637

## DESCRIPTION

- With TO-3PN package
- High voltage ,high speed
- High reliability

## APPLICATIONS

- Ultrahigh-definition CRT display horizontal deflection output applications

## PINNING

PIN	DESCRIPTION
1	Base
2	Collector;connected to mounting base
3	Emitter

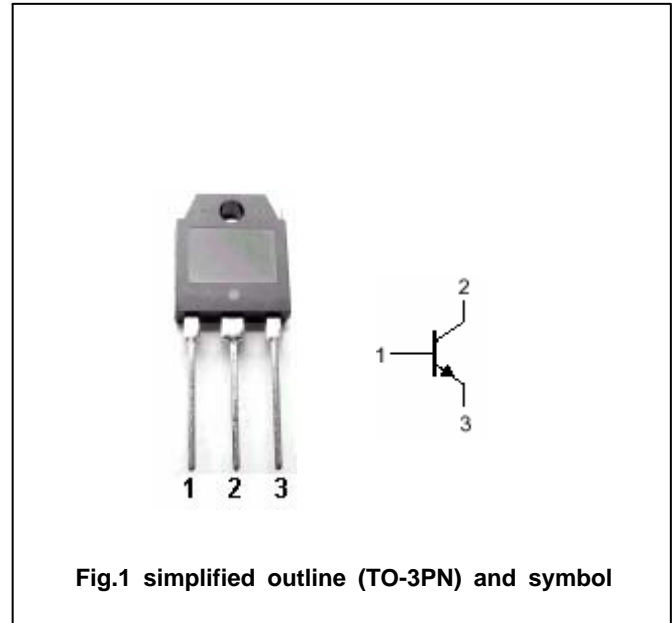
Absolute maximum ratings( $T_a =$ )

SYMBOL	PARAMETER	CONDITIONS	VALUE	UNIT
$V_{CBO}$	Collector-base voltage	Open emitter	900	V
$V_{CEO}$	Collector-emitter voltage	Open base	500	V
$V_{EBO}$	Emitter-base voltage	Open collector	7	V
$I_C$	Collector current		10	A
$I_{CM}$	Collector current-peak		20	A
$P_C$	Collector power dissipation	$T_C=25$	90	W
$T_j$	Junction temperature		150	
$T_{stg}$	Storage temperature		-55~150	

## Silicon NPN Power Transistors

## 2SC3637

## CHARACTERISTICS

T<sub>j</sub>=25 unless otherwise specified

SYMBOL	PARAMETER	CONDITIONS	MIN	TYP.	MAX	UNIT
V <sub>CE0(SUS)</sub>	Collector-emitter sustaining voltage	I <sub>C</sub> =100mA ; I <sub>B</sub> =0	500			V
V <sub>CEsat</sub>	Collector-emitter saturation voltage	I <sub>C</sub> =5A ; I <sub>B</sub> =1A			2.0	V
V <sub>BEsat</sub>	Base-emitter saturation voltage	I <sub>C</sub> =5A ; I <sub>B</sub> =1A			1.5	V
I <sub>CBO</sub>	Collector cut-off current	V <sub>CB</sub> =500V; I <sub>E</sub> =0			10	μA
I <sub>CES</sub>	Collector cut-off current	V <sub>CE</sub> =900V; R <sub>BE</sub> =0			0.5	mA
I <sub>EBO</sub>	Emitter cut-off current	V <sub>EB</sub> =5V; I <sub>C</sub> =0			1.0	mA
h <sub>FE</sub>	DC current gain	I <sub>C</sub> =1A ; V <sub>CE</sub> =5V	8			

## Switching times

t <sub>s</sub>	Storage time	V <sub>CC</sub> =200V; I <sub>C</sub> =5A; I <sub>B1</sub> =1A; I <sub>B2</sub> =-2A			3.0	μs
t <sub>f</sub>	Fall time			0.1	0.2	μs

Silicon NPN Power Transistors

2SC3637

PACKAGE OUTLINE

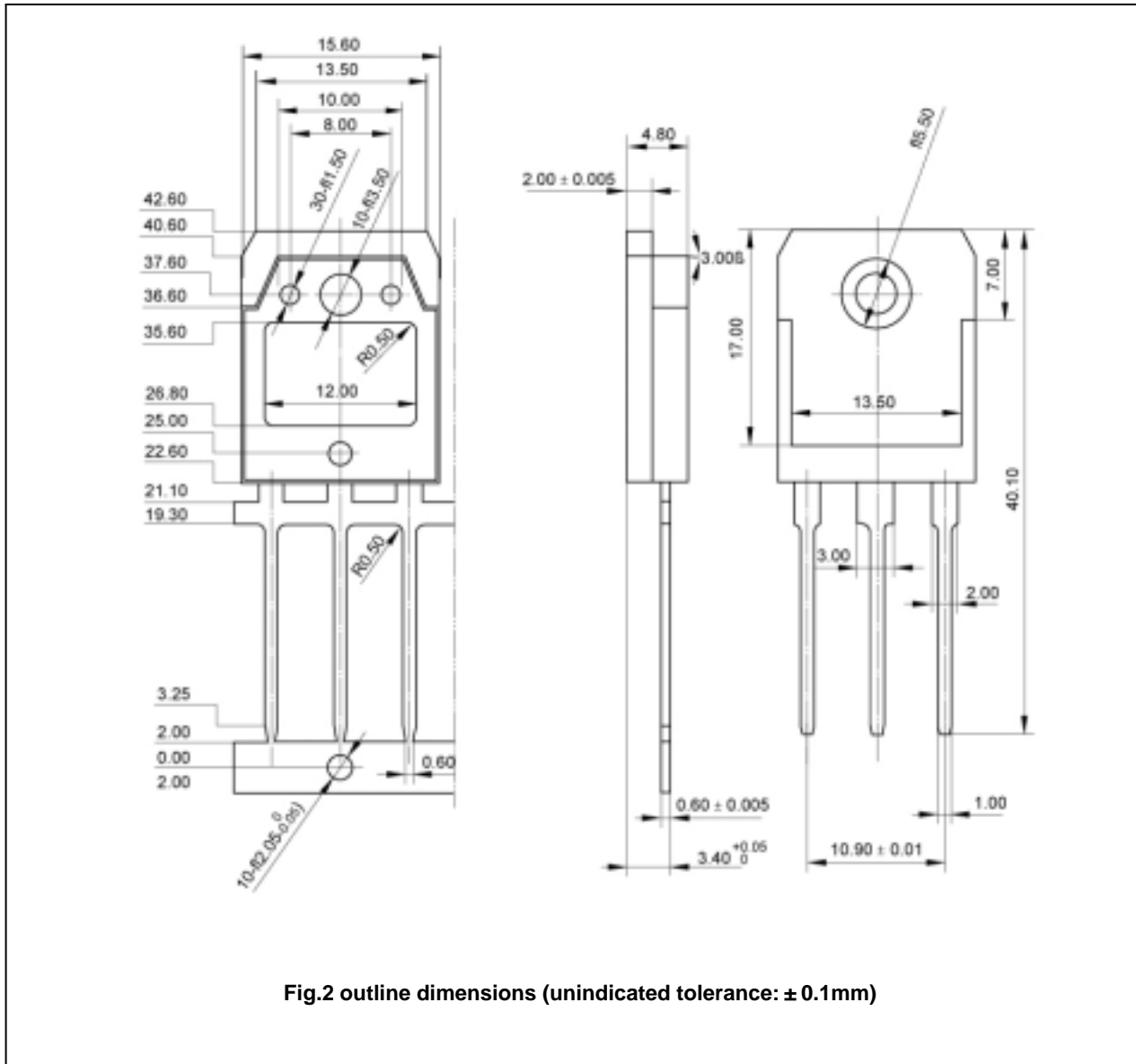

Fig.2 outline dimensions (unindicated tolerance: ± 0.1mm)

Silicon NPN Power Transistors

2SC3637

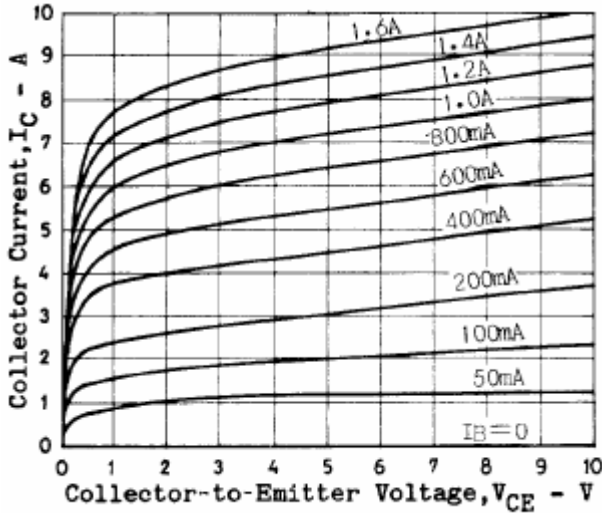

Fig.3 Static Characteristic

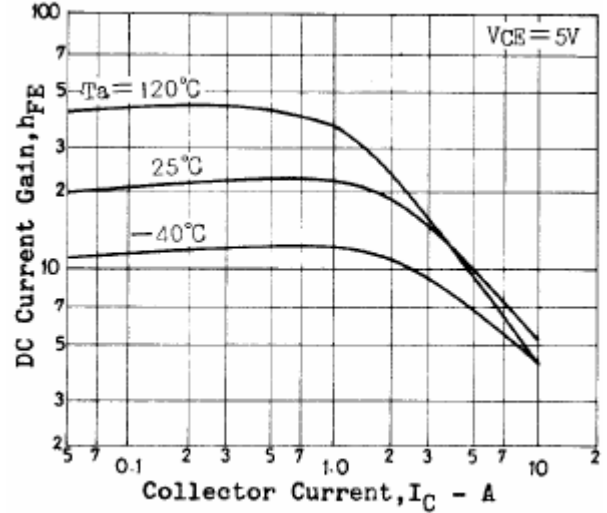

Fig.4 DC current Gain

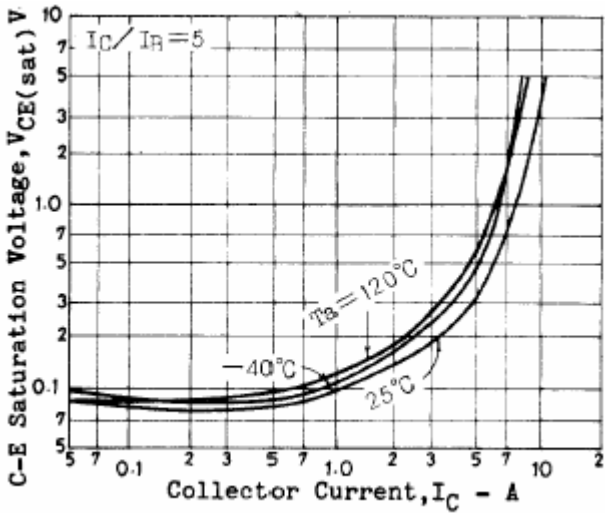

Fig.5 Collector-Emitter Saturation Voltage

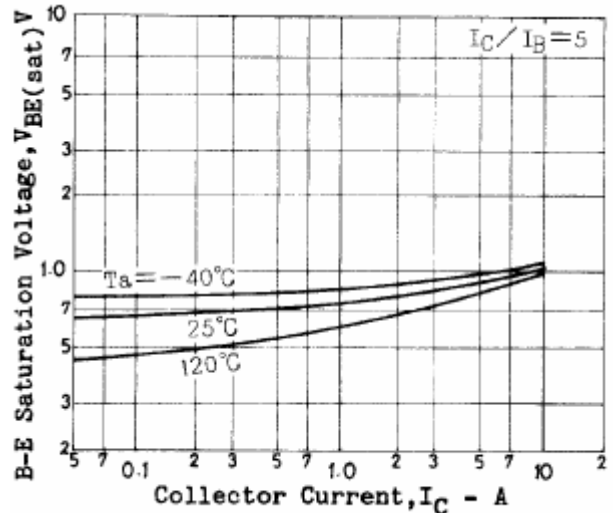

Fig.6 Base-Emitter Saturation Voltage

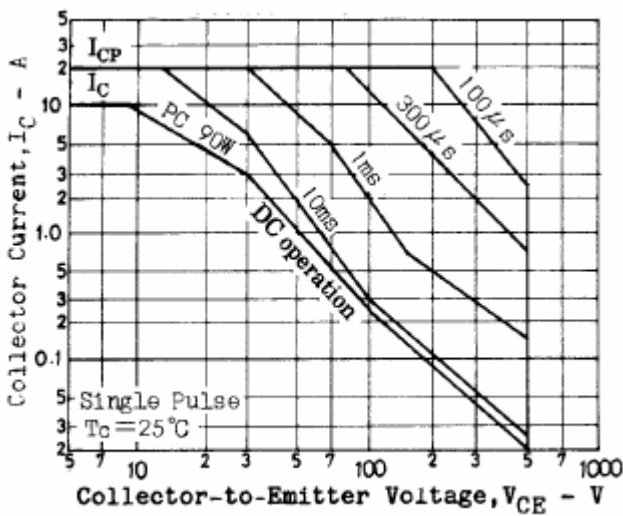

Fig.7 Safe Operating Area