

DATA SHEET

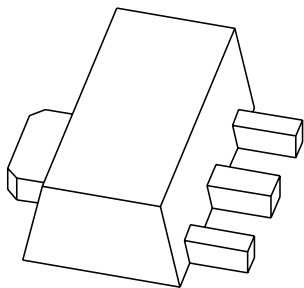

BFQ591

NPN 7 GHz wideband transistor

Product specification
Supersedes data of 2002 Jan 07

2002 Feb 04

NPN 7 GHz wideband transistor

BFQ591

FEATURES

- High power gain
- Low noise figure
- High transition frequency
- Gold metallization ensures excellent reliability.

APPLICATIONS

Intended for applications in the GHz range such as MATV or CATV amplifiers and RF communications subscribers equipment.

DESCRIPTION

NPN wideband transistor in a SOT89 plastic package.

MARKING

TYPE NUMBER	MARKING CODE
BFQ591	BCp

PINNING

PIN	DESCRIPTION
1	emitter
2	collector
3	base

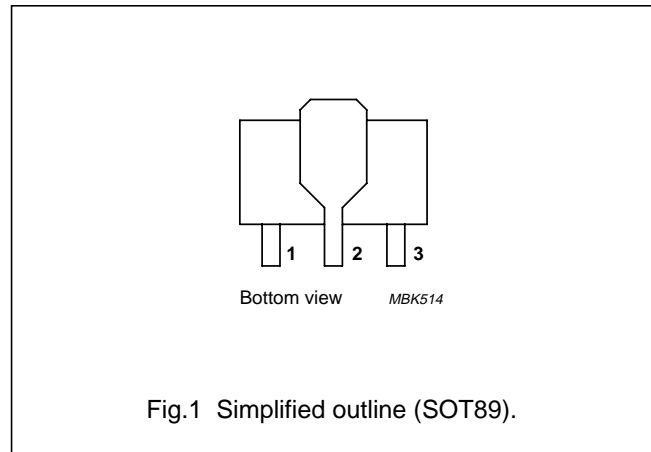

QUICK REFERENCE DATA

SYMBOL	PARAMETER	CONDITIONS	MIN.	TYP.	MAX.	UNIT
V_{CBO}	collector-base voltage	open emitter	–	–	20	V
V_{CEO}	collector-emitter voltage	open base	–	–	15	V
I_C	collector current (DC)		–	–	200	mA
P_{tot}	total power dissipation	$T_s \leq 90\text{ °C}$; note 1	–	–	2.25	W
h_{FE}	DC current gain	$I_C = 70\text{ mA}$; $V_{CE} = 8\text{ V}$	60	90	250	
C_{re}	feedback capacitance	$I_C = 0$; $V_{CB} = 12\text{ V}$; $f = 1\text{ MHz}$	–	0.8	–	pF
f_T	transition frequency	$I_C = 70\text{ mA}$; $V_{CE} = 12\text{ V}$; $f = 1\text{ GHz}$	–	7	–	GHz
G_{UM}	maximum unilateral power gain	$I_C = 70\text{ mA}$; $V_{CE} = 12\text{ V}$; $f = 900\text{ MHz}$; $T_{amb} = 25\text{ °C}$	–	11	–	dB
$ S_{21} ^2$	insertion power gain	$I_C = 70\text{ mA}$; $V_{CE} = 12\text{ V}$; $f = 900\text{ MHz}$; $T_{amb} = 25\text{ °C}$	–	10	–	dB

Note

1. T_s is the temperature at the soldering point of the collector pin.

NPN 7 GHz wideband transistor

BFQ591

LIMITING VALUES

In accordance with the Absolute Maximum System (IEC 60134).

SYMBOL	PARAMETER	CONDITIONS	MIN.	MAX.	UNIT
V_{CBO}	collector-base voltage	open emitter	–	20	V
V_{CEO}	collector-emitter voltage	open base	–	15	V
V_{EBO}	emitter-base voltage	open collector	–	3	V
I_C	collector current (DC)		–	200	mA
P_{tot}	total power dissipation	$T_s \leq 90\text{ °C}$; note 1	–	2.25	W
T_{stg}	storage temperature		–65	+150	°C
T_j	junction temperature		–	175	°C

Note

- T_s is the temperature at the soldering point of the collector pin.

THERMAL CHARACTERISTICS

SYMBOL	PARAMETER	CONDITIONS	VALUE	UNIT
$R_{th\ j-s}$	thermal resistance from junction to soldering point	$T_s \leq 90\text{ °C}$; note 1	38	K/W

Note

- T_s is the temperature at the soldering point of the collector pin.

NPN 7 GHz wideband transistor

BFQ591

CHARACTERISTICS

$T_j = 25\text{ °C}$; unless otherwise specified.

SYMBOL	PARAMETER	CONDITIONS	MIN.	TYP.	MAX.	UNIT
$V_{(BR)CBO}$	collector-base breakdown voltage	$I_C = 0.1\text{ mA}$; $I_E = 0$	–	–	20	V
$V_{(BR)CES}$	collector-emitter breakdown voltage	$I_C = 0.1\text{ mA}$; $I_B = 0$	–	–	15	V
$V_{(BR)EBO}$	emitter-base breakdown voltage	$I_E = 0.1\text{ mA}$; $I_C = 0$	–	–	3	V
I_{CBO}	collector-base leakage current	$I_E = 0$; $V_{CB} = 10$	–	–	100	nA
h_{FE}	DC current gain	$I_C = 70\text{ mA}$; $V_{CE} = 8\text{ V}$	60	90	250	
C_{re}	feedback capacitance	$I_C = 0$; $V_{CB} = 12\text{ V}$; $f = 1\text{ MHz}$	–	0.8	–	pF
f_T	transition frequency	$I_C = 70\text{ mA}$; $V_{CE} = 12\text{ V}$; $f = 1\text{ GHz}$	–	7	–	GHz
G_{UM}	maximum unilateral power gain; note 1	$I_C = 70\text{ mA}$; $V_{CE} = 12\text{ V}$; $T_{amb} = 25\text{ °C}$ $f = 900\text{ MHz}$ $f = 2\text{ GHz}$	–	11 5.5	–	dB dB
$ S_{21} ^2$	insertion power gain	$I_C = 70\text{ mA}$; $V_{CE} = 12\text{ V}$; $f = 1\text{ GHz}$; $T_{amb} = 25\text{ °C}$	–	10	–	dB
V_o	output voltage	note 2	–	700	–	mV

Notes

- G_{UM} is the maximum unilateral power gain, assuming s_{12} is zero and $G_{UM} = 10 \log \frac{|s_{21}|^2}{(1 - |s_{11}|^2)(1 - |s_{22}|^2)}$ dB.
- $d_{im} = 60\text{ dB}$ (DIN45004B); $V_p = V_o$; $V_q = V_o - 6\text{ dB}$; $f_p = 795.25\text{ MHz}$; $f_q = 803.25\text{ MHz}$; $f_r = 803.25\text{ MHz}$;
measured at $f_{(p+q+r)} = 793.25\text{ MHz}$.

NPN 7 GHz wideband transistor

BFQ591

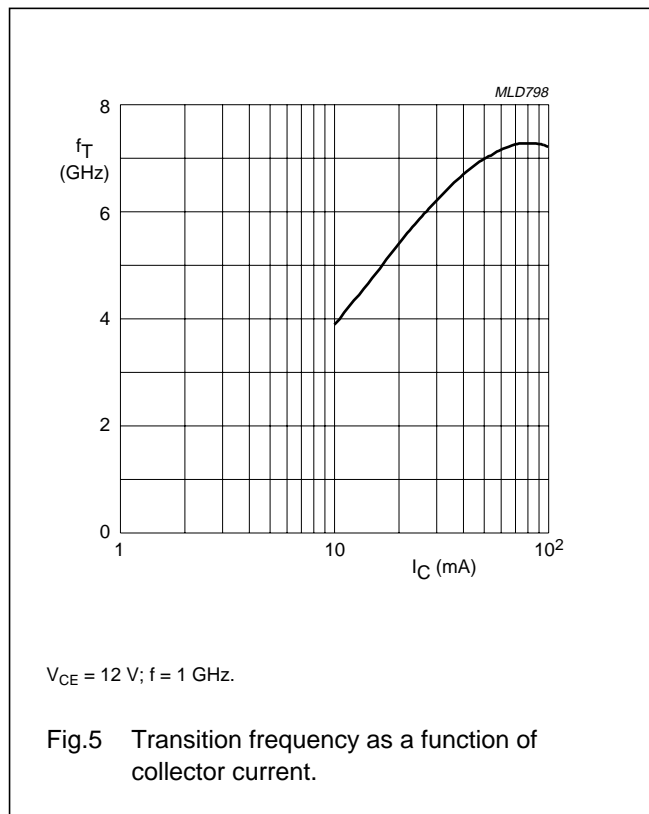
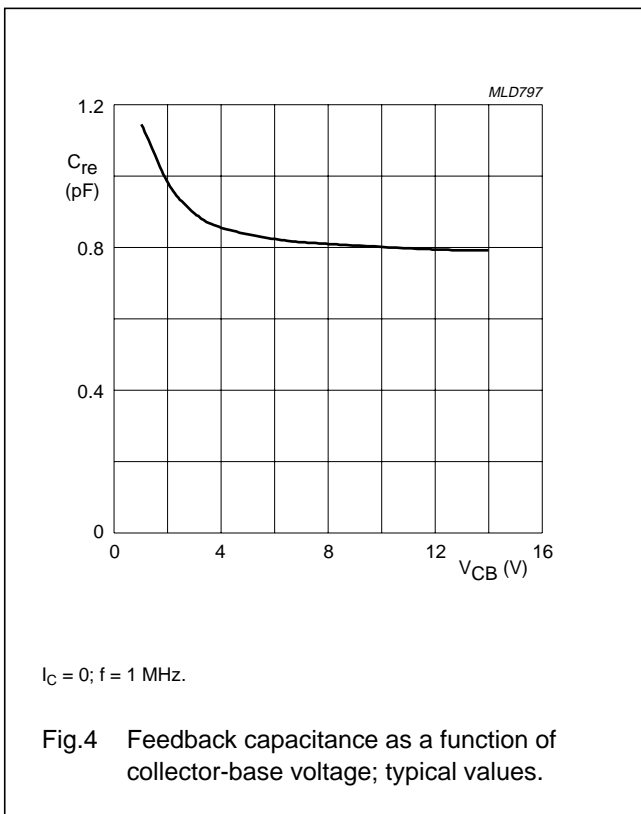
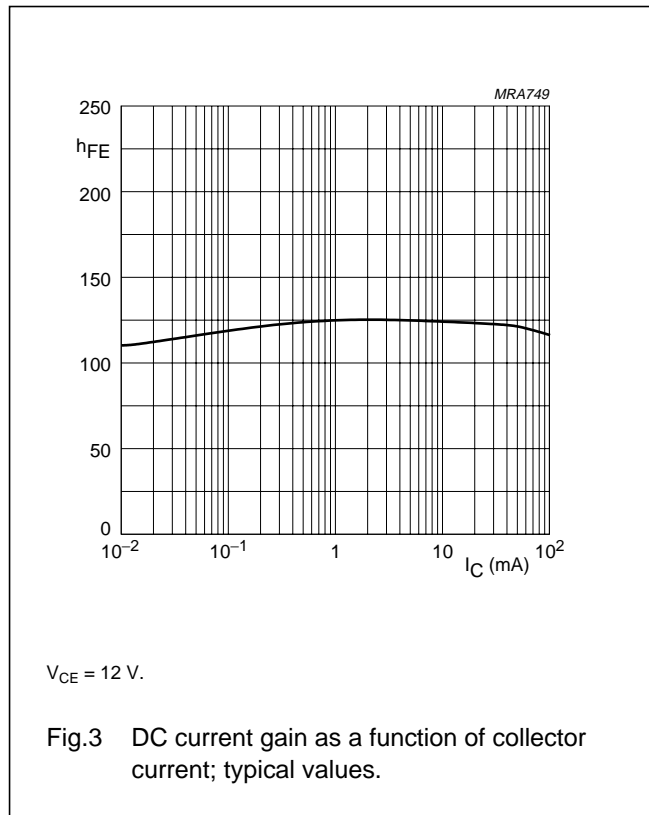
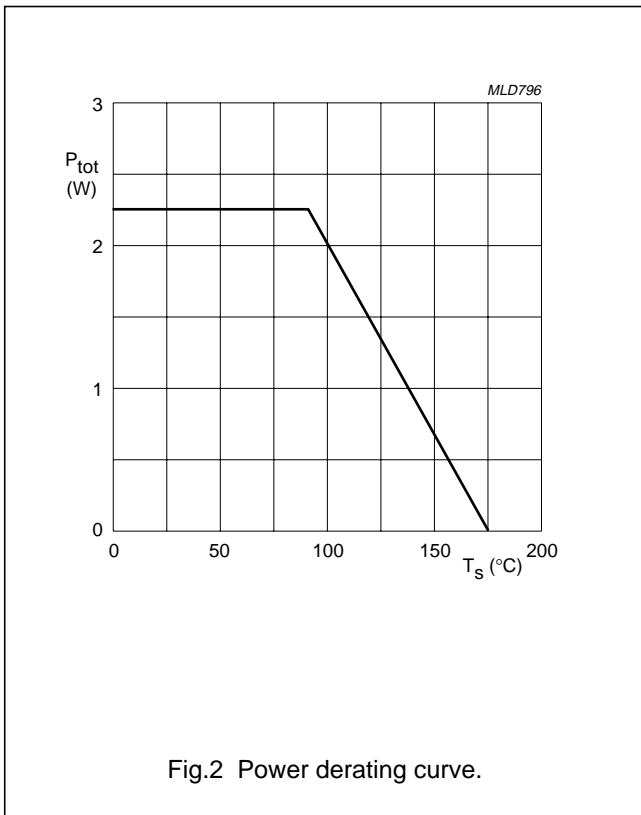

NPN 7 GHz wideband transistor

BFQ591

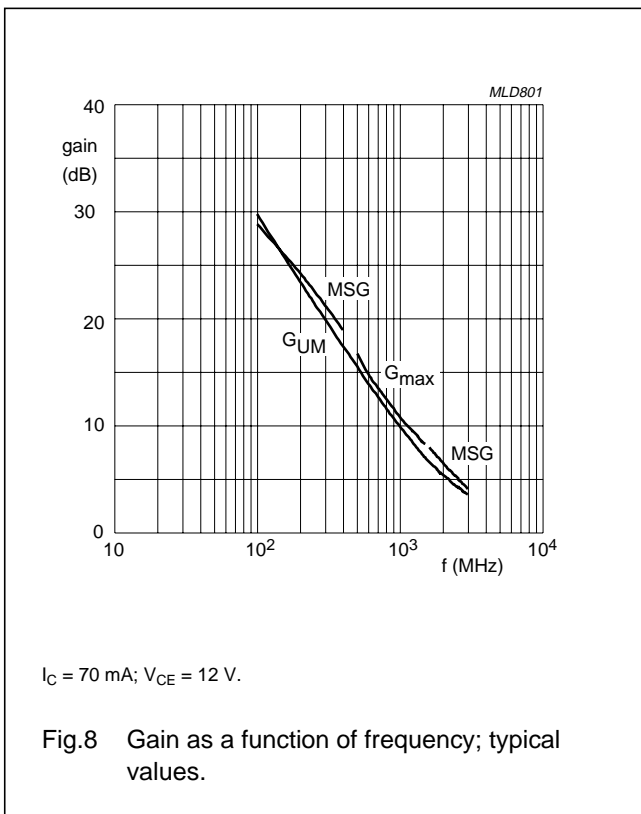
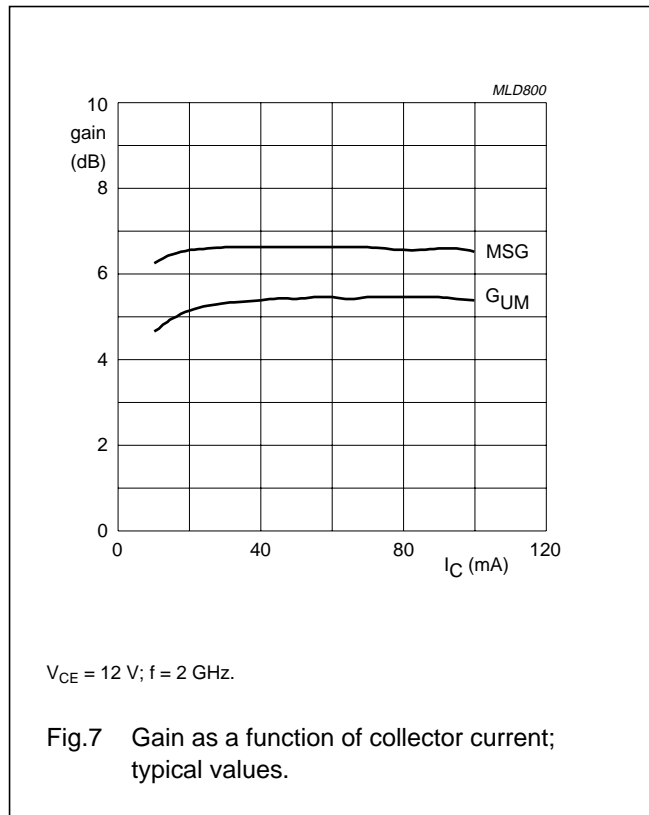
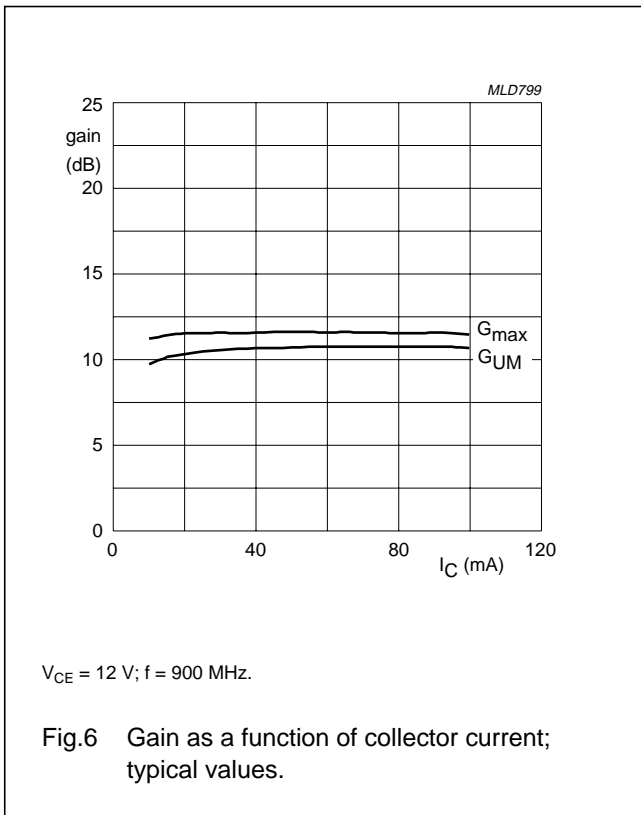

NPN 7 GHz wideband transistor

BFQ591

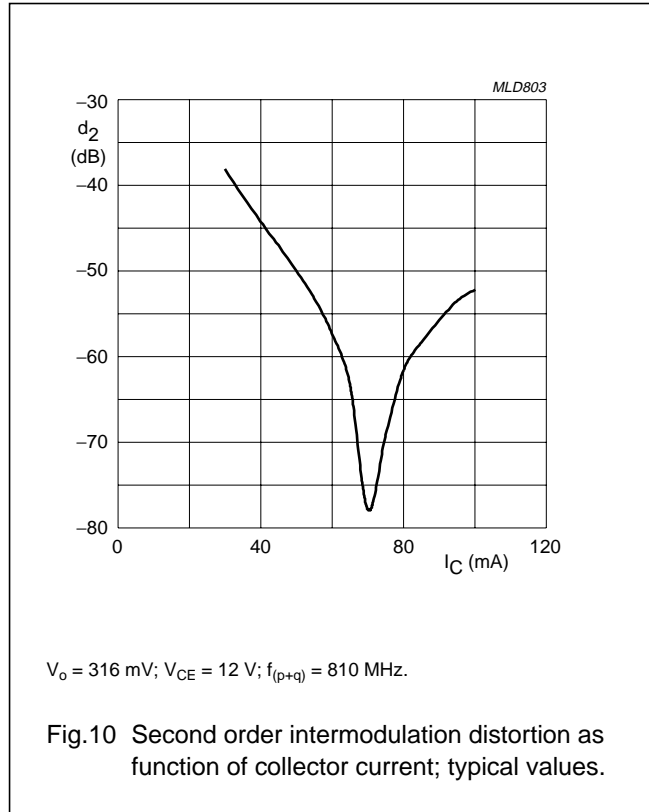
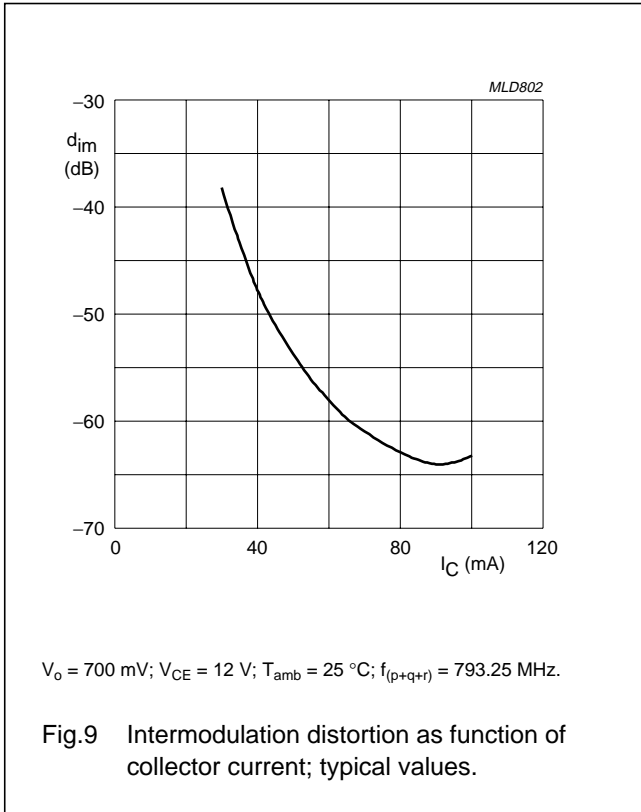

NPN 7 GHz wideband transistor

BFQ591

SPICE parameters for the BFQ591 die.

SEQUENCE No.	PARAMETER	VALUE	UNIT
1	IS	1.341	fA
2	BF	123.5	–
3	NF	.988	–
4	VAF	75.85	V
5	IKF	9.656	mA
6	ISE	232.2	fA
7	NE	2.134	–
8	BR	10.22	–
9	NR	1.016	–
10	VAR	1.992	V
11	IKR	294.1	mA
12	ISC	211.0	aA
13	NC	997.2	–
14	RB	5.00	Ω
15	IRB	1.000	μA
16	RBM	5.00	Ω
17	RE	1.275	Ω
18	RC	920.6	Ω
19 ⁽¹⁾	XTB	0.000	–
20 ⁽¹⁾	EG	1.110	eV
21 ⁽¹⁾	XTI	3.000	–
22	CJE	3.821	pF
23	VJE	600.0	mV
24	MJE	348.5	–
25	TF	13.60	ps
26	XTF	71.73	–
27	VTF	10.28	V
28	ITF	1.929	mA
29	PTF	0.000	deg
30	CJC	1.409	fF
31	VJC	219.4	mV
32	MJC	166.5	–
33	XCJ	2.340	–
34	TR	543.7	ps
35 ⁽¹⁾	CJS	0.000	F
36 ⁽¹⁾	VJS	750.0	mV
37 ⁽¹⁾	MJS	0.000	–
38	FC	733.2	–

Note

1. These parameters have not been extracted, the default values are shown.

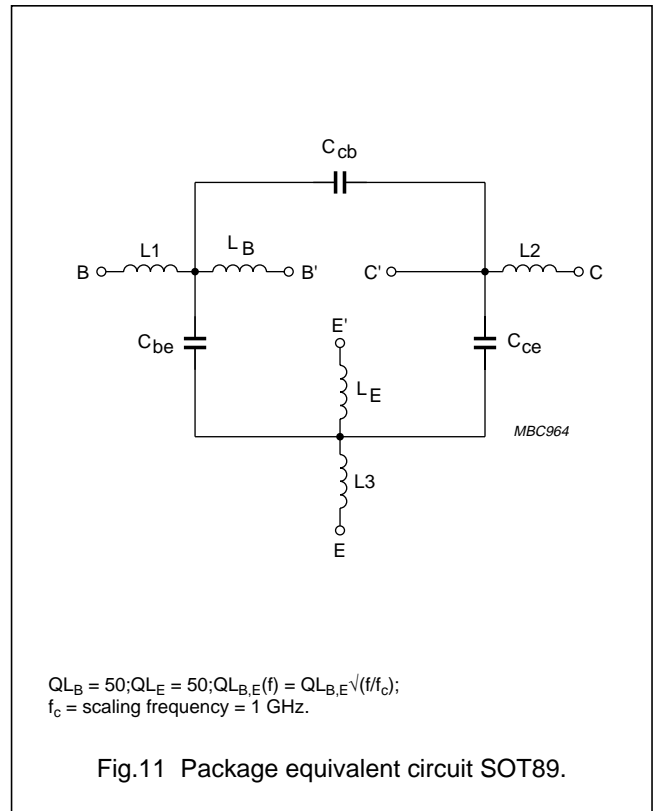

Fig.11 Package equivalent circuit SOT89.

List of components (see Fig.11)

DESIGNATION	VALUE	UNIT
C _{be}	16	fF
C _{cb}	150	fF
C _{ce}	150	fF
L1	1	nH
L2	0.01	nH
L3	1	nH
L _B	1.2	nH
L _E	1.2	nH

NPN 7 GHz wideband transistor

BFQ591

PACKAGE OUTLINE

Plastic surface mounted package; collector pad for good heat transfer; 3 leads

SOT89

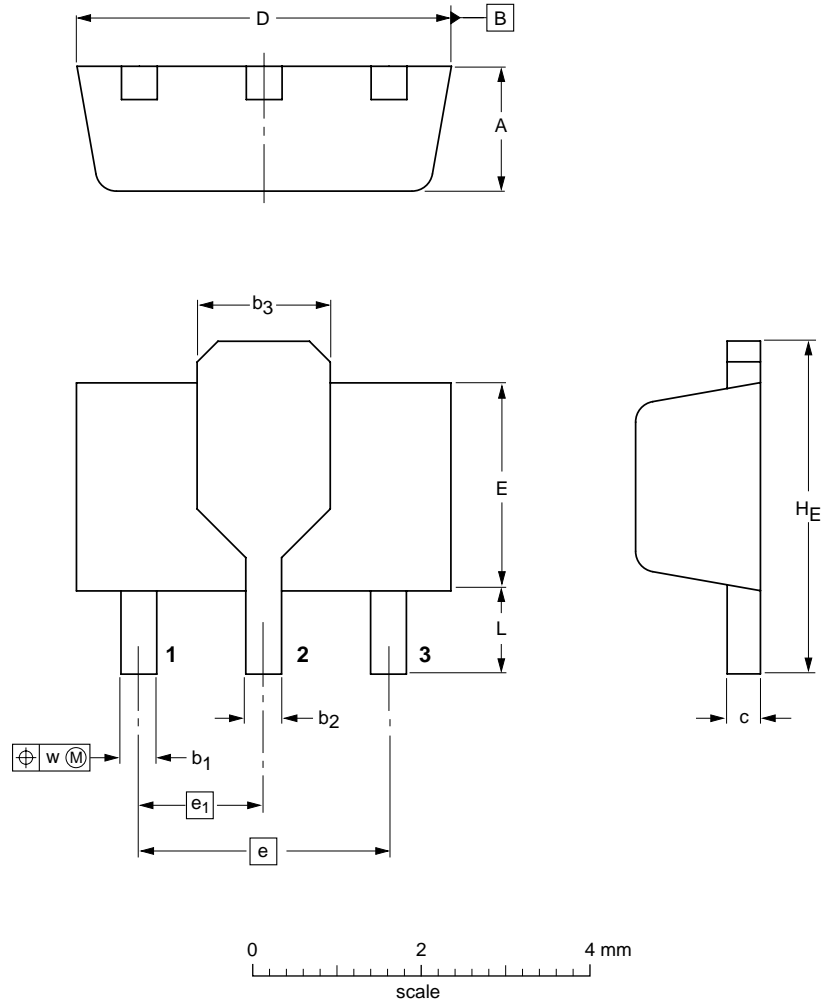

DIMENSIONS (mm are the original dimensions)

UNIT	A	b ₁	b ₂	b ₃	c	D	E	e	e ₁	H _E	L min.	w
mm	1.6 1.4	0.48 0.35	0.53 0.40	1.8 1.4	0.44 0.37	4.6 4.4	2.6 2.4	3.0	1.5	4.25 3.75	0.8	0.13

OUTLINE VERSION	REFERENCES			EUROPEAN PROJECTION	ISSUE DATE
	IEC	JEDEC	EIAJ		
SOT89		TO-243	SC-62		97-02-28 99-09-13

NPN 7 GHz wideband transistor

BFQ591

DATA SHEET STATUS

DATA SHEET STATUS ⁽¹⁾	PRODUCT STATUS ⁽²⁾	DEFINITIONS
Objective data	Development	This data sheet contains data from the objective specification for product development. Philips Semiconductors reserves the right to change the specification in any manner without notice.
Preliminary data	Qualification	This data sheet contains data from the preliminary specification. Supplementary data will be published at a later date. Philips Semiconductors reserves the right to change the specification without notice, in order to improve the design and supply the best possible product.
Product data	Production	This data sheet contains data from the product specification. Philips Semiconductors reserves the right to make changes at any time in order to improve the design, manufacturing and supply. Changes will be communicated according to the Customer Product/Process Change Notification (CPCN) procedure SNW-SQ-650A.

Notes

1. Please consult the most recently issued data sheet before initiating or completing a design.
2. The product status of the device(s) described in this data sheet may have changed since this data sheet was published. The latest information is available on the Internet at URL <http://www.semiconductors.philips.com>.

DEFINITIONS

Short-form specification — The data in a short-form specification is extracted from a full data sheet with the same type number and title. For detailed information see the relevant data sheet or data handbook.

Limiting values definition — Limiting values given are in accordance with the Absolute Maximum Rating System (IEC 60134). Stress above one or more of the limiting values may cause permanent damage to the device. These are stress ratings only and operation of the device at these or at any other conditions above those given in the Characteristics sections of the specification is not implied. Exposure to limiting values for extended periods may affect device reliability.

Application information — Applications that are described herein for any of these products are for illustrative purposes only. Philips Semiconductors make no representation or warranty that such applications will be suitable for the specified use without further testing or modification.

DISCLAIMERS

Life support applications — These products are not designed for use in life support appliances, devices, or systems where malfunction of these products can reasonably be expected to result in personal injury. Philips Semiconductors customers using or selling these products for use in such applications do so at their own risk and agree to fully indemnify Philips Semiconductors for any damages resulting from such application.

Right to make changes — Philips Semiconductors reserves the right to make changes, without notice, in the products, including circuits, standard cells, and/or software, described or contained herein in order to improve design and/or performance. Philips Semiconductors assumes no responsibility or liability for the use of any of these products, conveys no licence or title under any patent, copyright, or mask work right to these products, and makes no representations or warranties that these products are free from patent, copyright, or mask work right infringement, unless otherwise specified.

NPN 7 GHz wideband transistor

BFQ591

NOTES

Philips Semiconductors – a worldwide company

Contact information

For additional information please visit <http://www.semiconductors.philips.com>. Fax: +31 40 27 24825

For sales offices addresses send e-mail to: sales.addresses@www.semiconductors.philips.com.

© Koninklijke Philips Electronics N.V. 2002

SCA74

All rights are reserved. Reproduction in whole or in part is prohibited without the prior written consent of the copyright owner.

The information presented in this document does not form part of any quotation or contract, is believed to be accurate and reliable and may be changed without notice. No liability will be accepted by the publisher for any consequence of its use. Publication thereof does not convey nor imply any license under patent- or other industrial or intellectual property rights.

Printed in The Netherlands

613516/03/pp12

Date of release: 2002 Feb 04

Document order number: 9397 750 09271

Let's make things better.

**Philips
Semiconductors**



PHILIPS