

# DATA SHEET

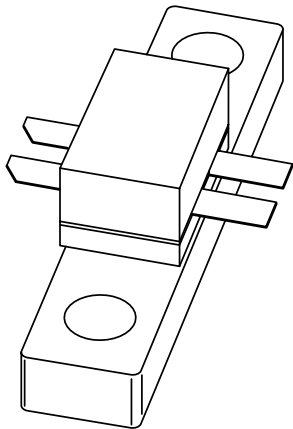

## **BLF245B**

VHF push-pull power MOS  
transistor

Product specification  
Supersedes data of 1998 Jan 08

2000 Oct 17

# VHF push-pull power MOS transistor

# BLF245B

## FEATURES

- High power gain
- Easy power control
- Good thermal stability
- Gold metallization ensures excellent reliability.

## DESCRIPTION

Dual push-pull silicon N-channel enhancement mode vertical D-MOS transistor designed for large signal amplifier applications in the VHF frequency range.

The transistor is encapsulated in a 4-lead, SOT279 balanced flange envelope, with a ceramic cap. The mounting flange provides the common source connection for the transistors.

## PIN CONFIGURATION

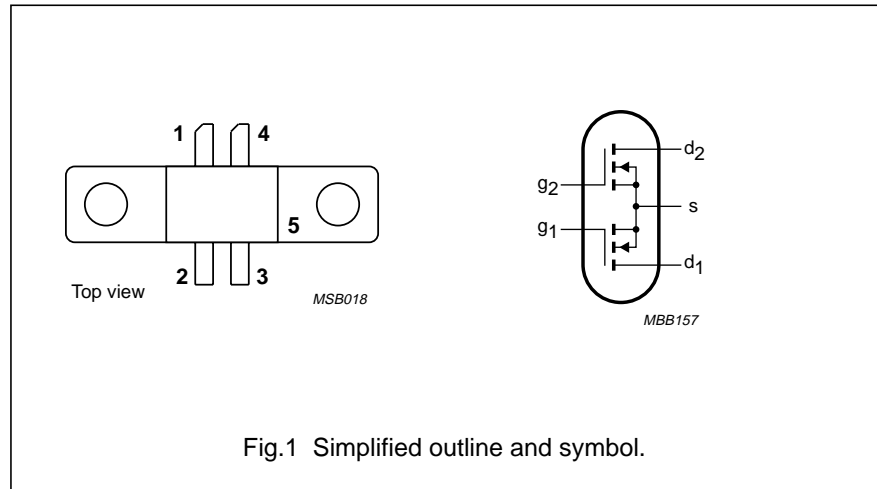

## PINNING - SOT279

PIN	DESCRIPTION
1	drain 1
2	gate 1
3	gate 2
4	drain 2
5	source

**CAUTION**

The device is supplied in an antistatic package. The gate-source input must be protected against static charge during transport and handling.

**WARNING**

**Product and environmental safety - toxic materials**

This product contains beryllium oxide. The product is entirely safe provided that the BeO disc is not damaged. All persons who handle, use or dispose of this product should be aware of its nature and of the necessary safety precautions. After use, dispose of as chemical or special waste according to the regulations applying at the location of the user. It must never be thrown out with the general or domestic waste.

## QUICK REFERENCE DATA

RF performance at  $T_h = 25\text{ }^\circ\text{C}$  in a push-pull common source test circuit.

MODE OF OPERATION	f (MHz)	$V_{DS}$ (V)	$P_L$ (W)	$G_p$ (dB)	$\eta_D$ (%)
CW, class-B	175	28	30	> 14	> 55

# VHF push-pull power MOS transistor

# BLF245B

## LIMITING VALUES

In accordance with the Absolute Maximum System (IEC 60134).  
Per transistor section unless otherwise specified.

SYMBOL	PARAMETER	CONDITIONS	MIN.	MAX.	UNIT
$V_{DS}$	drain-source voltage		–	65	V
$\pm V_{GS}$	gate-source voltage		–	20	V
$I_D$	DC drain current		–	4.5	A
$P_{tot}$	total power dissipation	up to $T_{mb} = 25\text{ °C}$ ; total device; both sections equally loaded	–	75	W
$T_{stg}$	storage temperature		–65	+150	°C
$T_j$	junction temperature		–	200	°C

## THERMAL CHARACTERISTICS

SYMBOL	PARAMETER	CONDITIONS	VALUE	UNIT
$R_{th\ j-mb}$	thermal resistance from junction to mounting base	total device; both sections equally loaded	2.3	K/W
$R_{th\ mb-h}$	thermal resistance from mounting base to heatsink	total device; both sections equally loaded	0.3	K/W

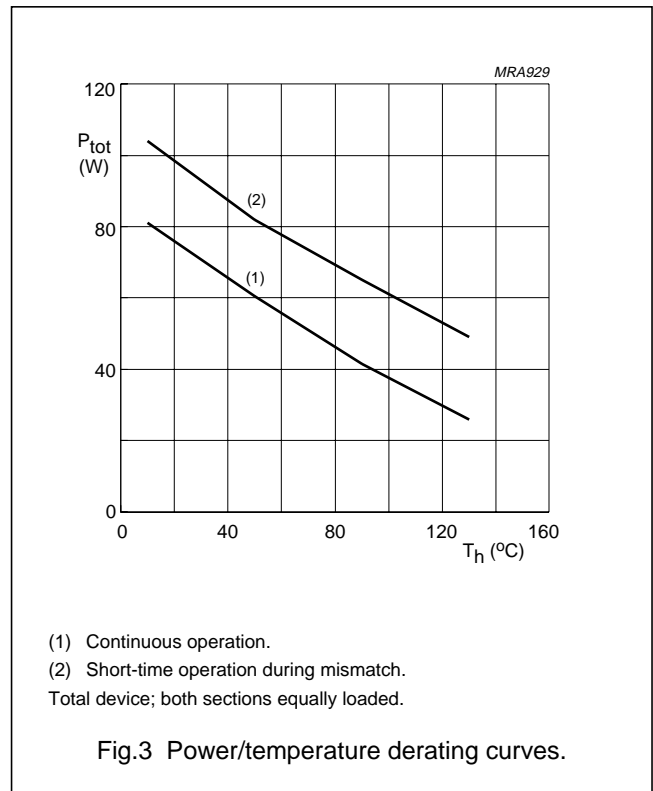
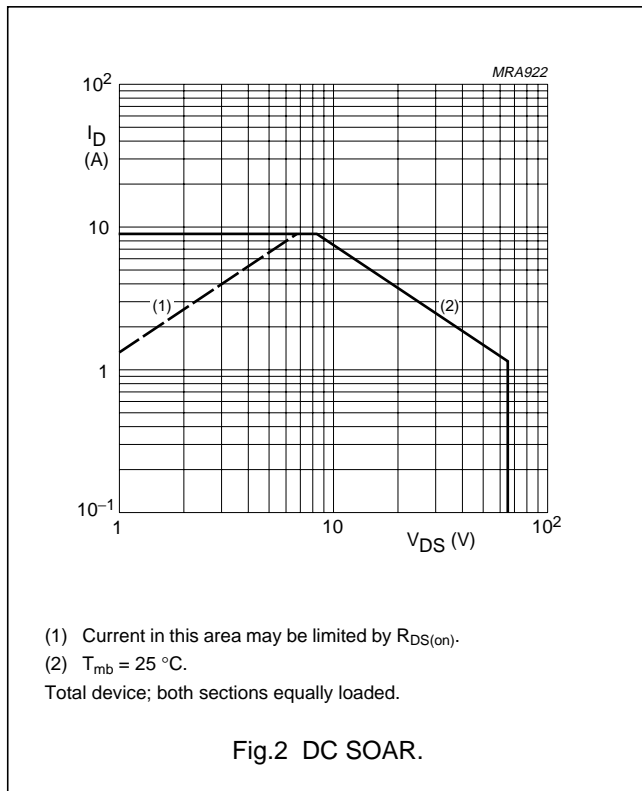

VHF push-pull power MOS transistor

BLF245B

**CHARACTERISTICS (per section)**

T<sub>j</sub> = 25 °C unless otherwise specified.

SYMBOL	PARAMETER	CONDITIONS	MIN.	TYP.	MAX.	UNIT
V <sub>(BR)DSS</sub>	drain-source breakdown voltage	I <sub>D</sub> = 5 mA; V <sub>GS</sub> = 0	65	–	–	V
I <sub>DSS</sub>	drain-source leakage current	V <sub>GS</sub> = 0; V <sub>DS</sub> = 28 V	–	–	1	mA
I <sub>GSS</sub>	gate-source leakage current	±V <sub>GS</sub> = 20 V; V <sub>DS</sub> = 0	–	–	1	μA
V <sub>GS(th)</sub>	gate-source threshold voltage	I <sub>D</sub> = 5 mA; V <sub>DS</sub> = 10 V	2	–	4.5	V
g <sub>fs</sub>	forward transconductance	I <sub>D</sub> = 0.75 A; V <sub>DS</sub> = 10 V	600	850	–	mS
R <sub>DS(on)</sub>	drain-source on-state resistance	I <sub>D</sub> = 0.75 A; V <sub>GS</sub> = 10 V	–	0.8	1.5	Ω
I <sub>DSX</sub>	on-state drain current	V <sub>GS</sub> = 10 V; V <sub>DS</sub> = 10 V	–	5	–	A
C <sub>is</sub>	input capacitance	V <sub>GS</sub> = 0; V <sub>DS</sub> = 28 V; f = 1 MHz	–	60	–	pF
C <sub>os</sub>	output capacitance	V <sub>GS</sub> = 0; V <sub>DS</sub> = 28 V; f = 1 MHz	–	40	–	pF
C <sub>rs</sub>	feedback capacitance	V <sub>GS</sub> = 0; V <sub>DS</sub> = 28 V; f = 1 MHz	–	4.5	–	pF

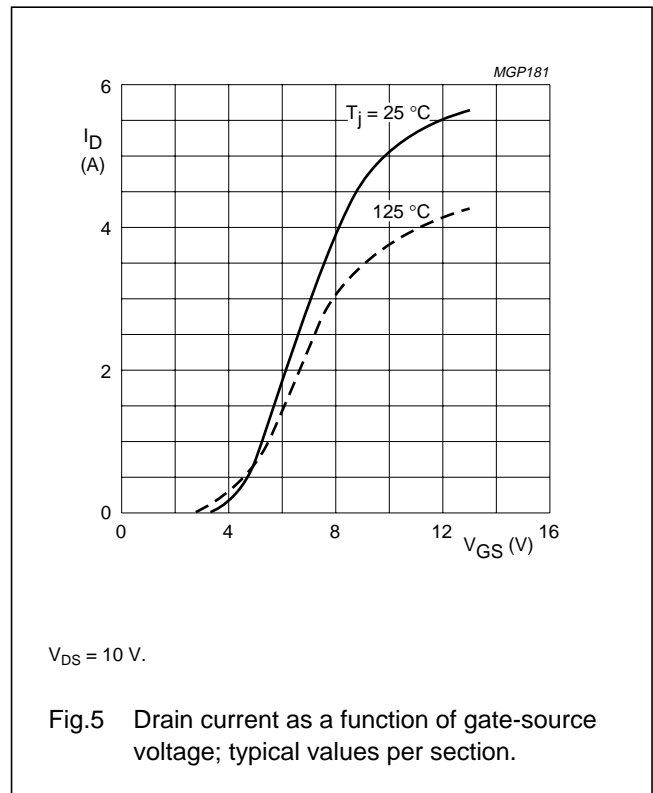
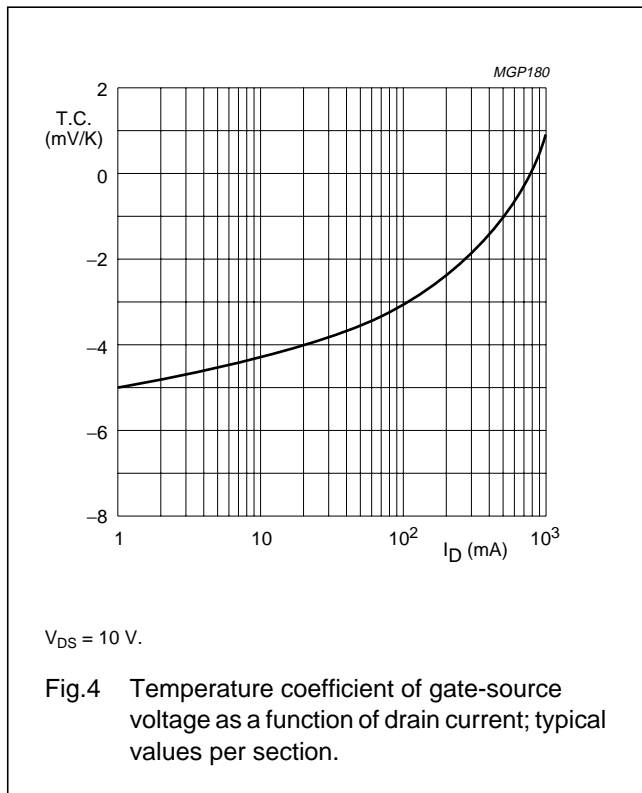

VHF push-pull power MOS transistor

BLF245B

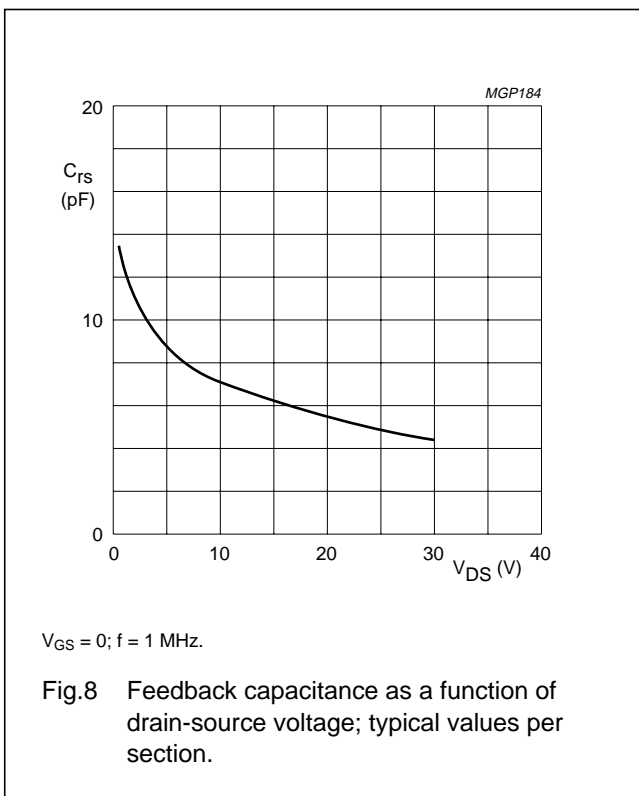
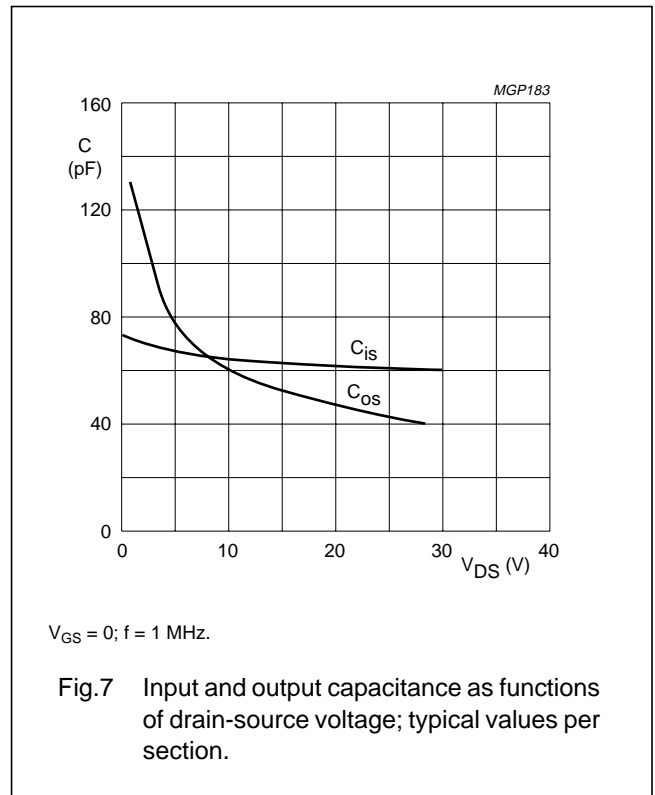
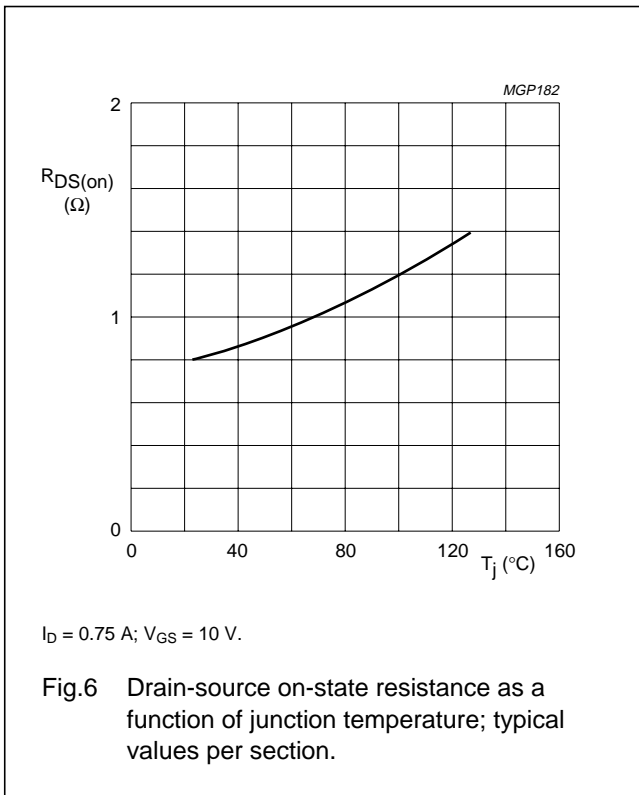

VHF push-pull power MOS transistor

BLF245B

**APPLICATION INFORMATION FOR CLASS-B OPERATION**

$T_h = 25\text{ }^\circ\text{C}$ ;  $R_{th\text{ mb-h}} = 0.3\text{ K/W}$ ; unless otherwise specified.

RF performance in a push-pull, common source, class-B test circuit.

MODE OF OPERATION	f (MHz)	V <sub>DS</sub> (V)	I <sub>DQ</sub> (mA)	P <sub>L</sub> (W)	G <sub>p</sub> (dB)	η <sub>D</sub> (%)
CW, class-B	175	28	2 × 25	30	> 14 typ. 18	> 55 typ. 65

**Ruggedness in class-B operation**

The BLF245B is capable of withstanding a load mismatch corresponding to VSWR = 50 through all phases, under the following conditions:

V<sub>DS</sub> = 28 V, f = 175 MHz at rated output power.

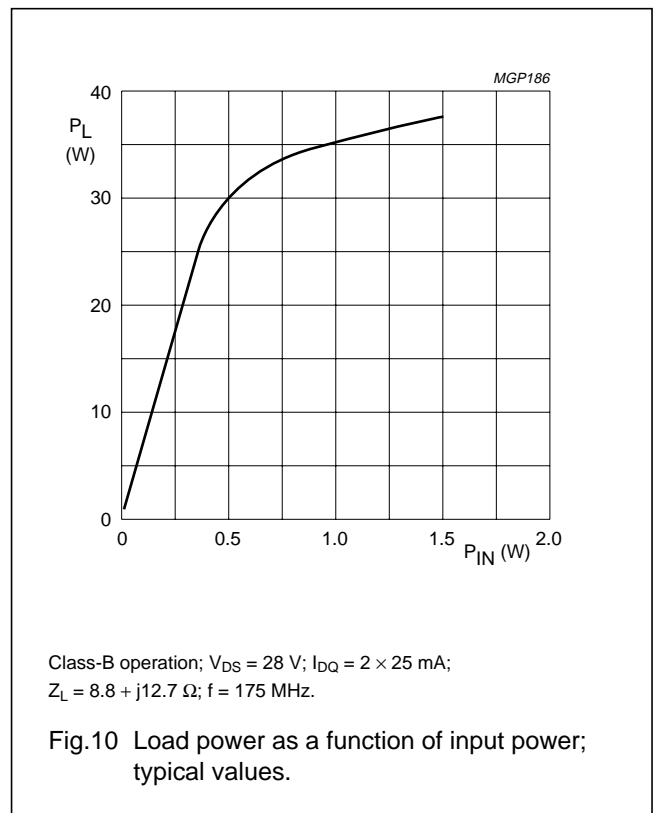
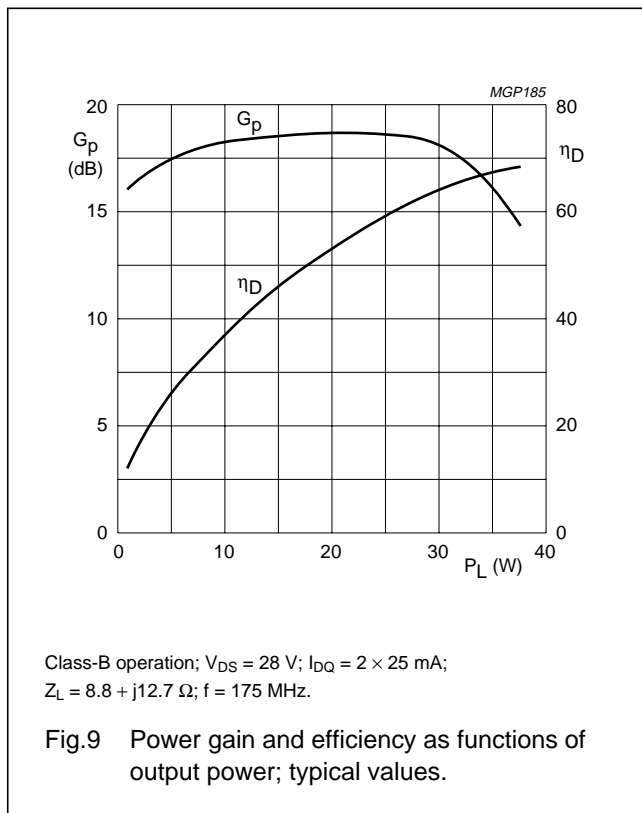

VHF push-pull power MOS transistor

BLF245B

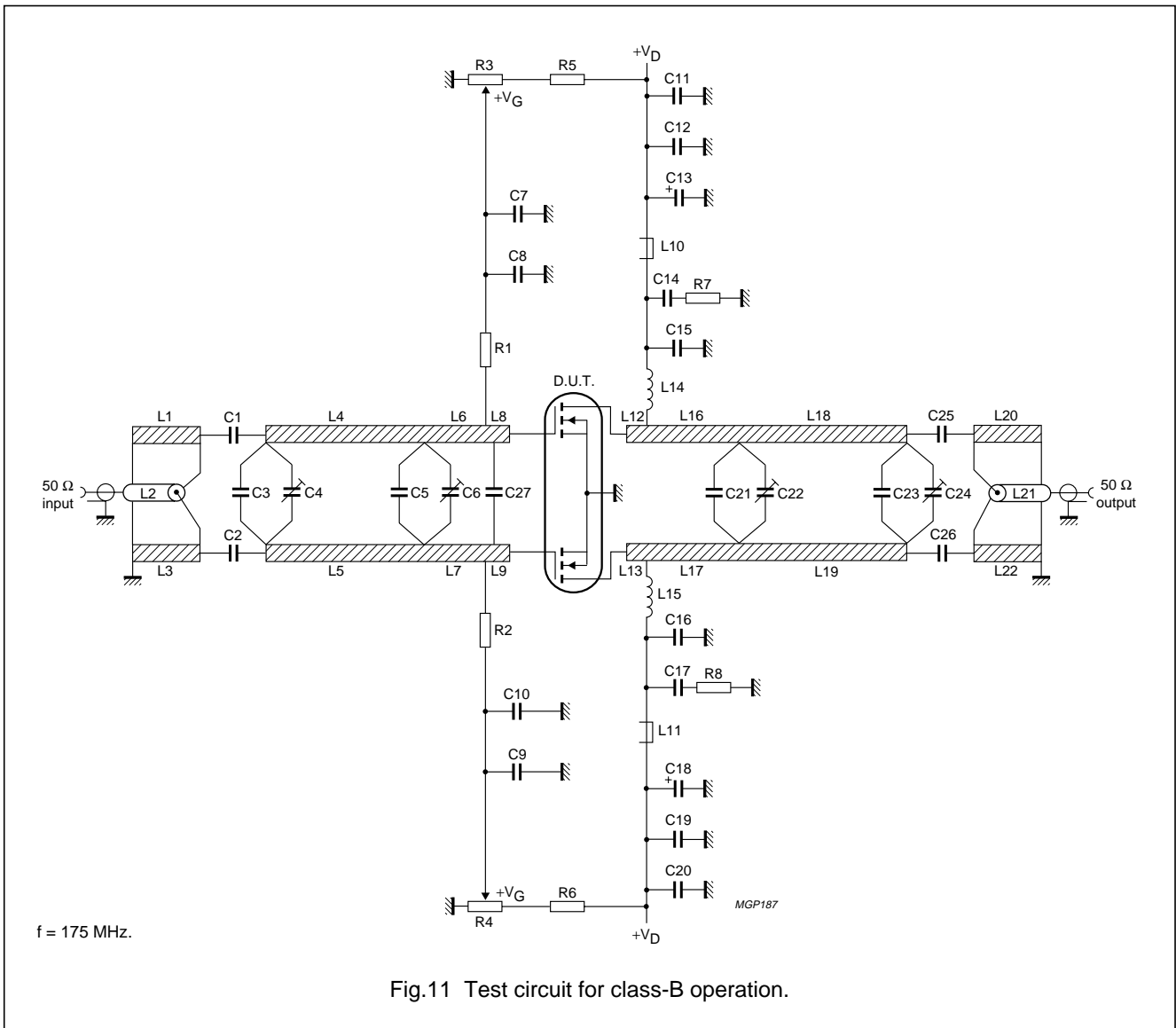

List of components (see Fig.11)

COMPONENT	DESCRIPTION	VALUE	DIMENSIONS	CATALOGUE NO.
C1,C2	multilayer ceramic chip capacitor; note 1	270 pF		
C3	multilayer ceramic chip capacitor; note 1	24 pF		
C4	film dielectric trimmer	4 to 60 pF		2222 809 08002
C5, C25, C26	multilayer ceramic chip capacitor; note 1	91 pF		
C6, C22, C24	film dielectric trimmer	5 to 60 pF		2222 809 08003

## VHF push-pull power MOS transistor

## BLF245B

COMPONENT	DESCRIPTION	VALUE	DIMENSIONS	CATALOGUE NO.
C7, C9, C12, C14, C17, C19	multilayer ceramic chip capacitor	100 nF		2222 852 47104
C8, C10	multilayer ceramic chip capacitor; note 1	680 pF		
C11, C20	multilayer ceramic chip capacitor	10 nF		2222 852 47103
C13, C18	electrolytic capacitor	10 $\mu$ F, 63 V		
C15, C16	multilayer ceramic chip capacitor; note 1	100 pF		
C21, C27	multilayer ceramic chip capacitor; note 1	75 pF		
C23	multilayer ceramic chip capacitor; note 1	36 pF		
L1, L3, L20, L22	stripline; note 2	55 $\Omega$	length 111 mm width 2.5 mm	
L2, L21	semi-rigid cable	50 $\Omega$	length 111 mm ext. dia. 2.2 mm	
L4, L5	stripline; note 2	49.5 $\Omega$	length 28 mm width 3 mm	
L6, L7	stripline; note 2	49.5 $\Omega$	length 22.5 mm width 3 mm	
L8, L9	stripline; note 2	49.5 $\Omega$	length 4.5 mm width 3 mm	
L10, L11	grade 3B Ferroxcube RF choke			4312 020 36642
L12, L13	stripline; note 2	49.5 $\Omega$	length 21 mm width 3 mm	
L14, L15	4 turns enamelled 1 mm copper wire	70 nH	length 9 mm int. dia. 6 mm leads 2 $\times$ 5 mm	
L16, L17	stripline; note 2	49.5 $\Omega$	length 30 mm width 3 mm	
L18, L19	stripline; note 2	49.5 $\Omega$	length 26 mm width 3 mm	
R1, R2	0.4 W metal film resistor	10 $\Omega$		
R3, R4	10 turns potentiometer	50 $\Omega$		
R5, R6	0.4 W metal film resistor	205 k $\Omega$		
R7, R8	0.4 W metal film resistor	10 $\Omega$		

**Notes**

- American Technical Ceramics (ATC) capacitor, type 100B or other capacitor of the same quality.
- The striplines are on a double copper-clad printed circuit board, with epoxy glass dielectric ( $\epsilon_r = 4.5$ ), thickness  $\frac{1}{16}$  inch. The other side of the board is fully metallized and used as a ground plane. The ground planes on each side of the board are connected together by means of copper straps and hollow rivets.



VHF push-pull power MOS transistor

BLF245B

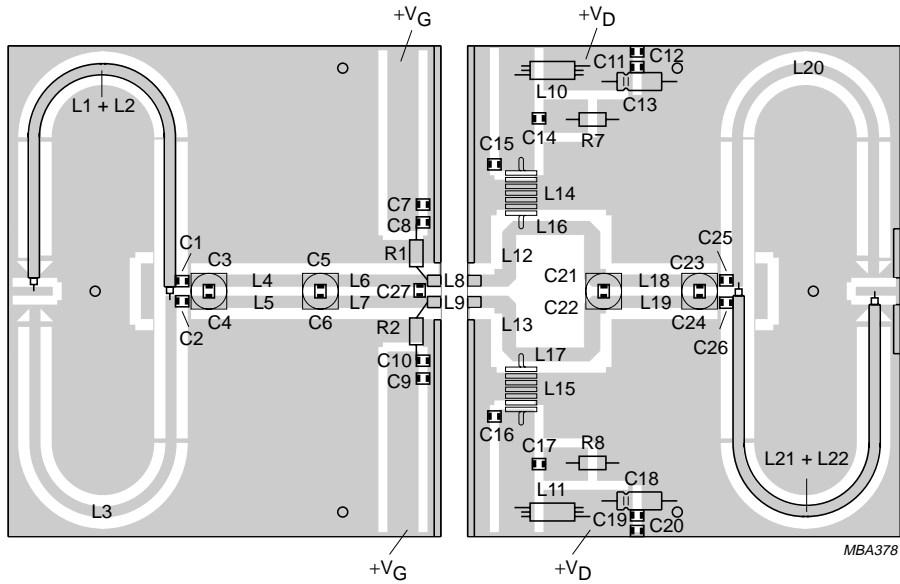
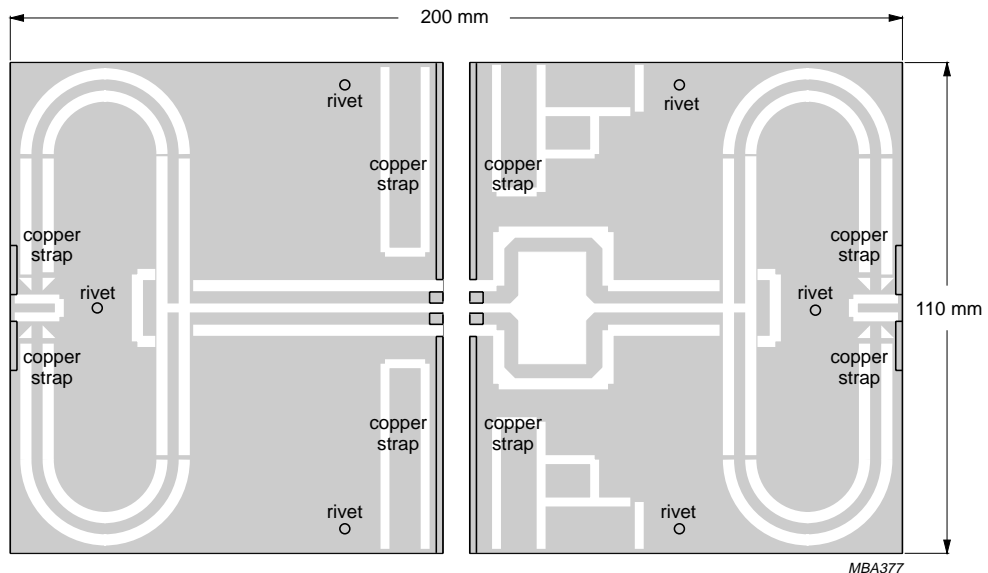

The circuit and components are situated on one side of the epoxy fibre-glass board, the other side being fully metallized to serve as a ground. Earth connections are made by means of copper straps and hollow rivets for a direct contact between the upper and lower sheets.

Fig.12 Component layout for 175 MHz test circuit.

VHF push-pull power MOS transistor

BLF245B

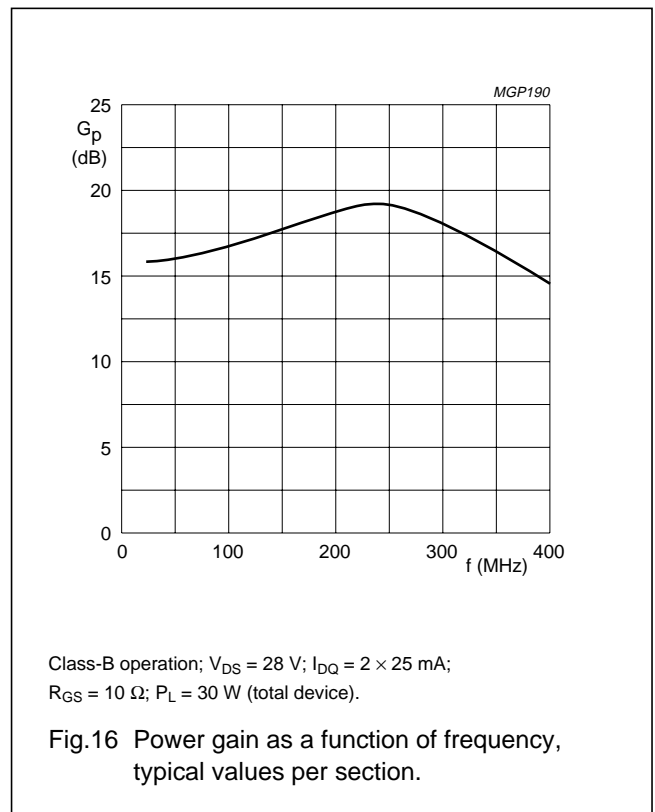
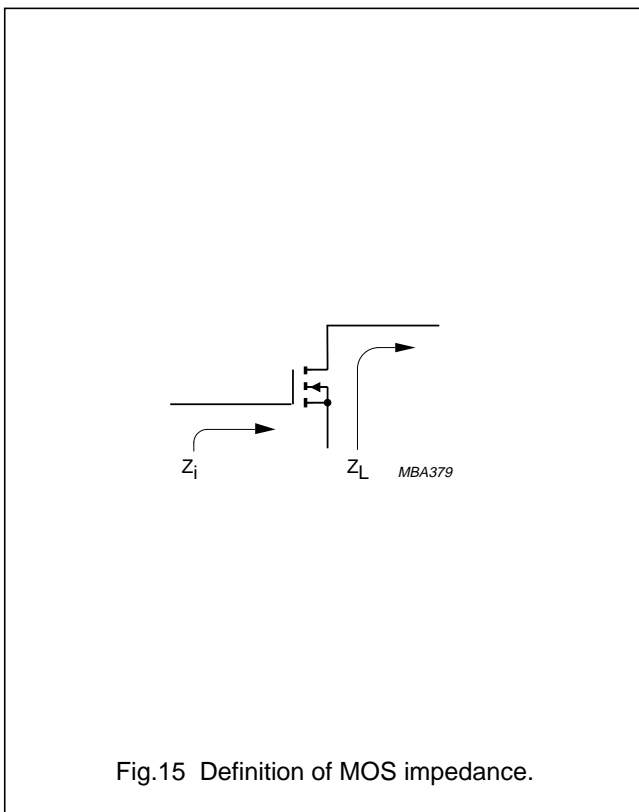
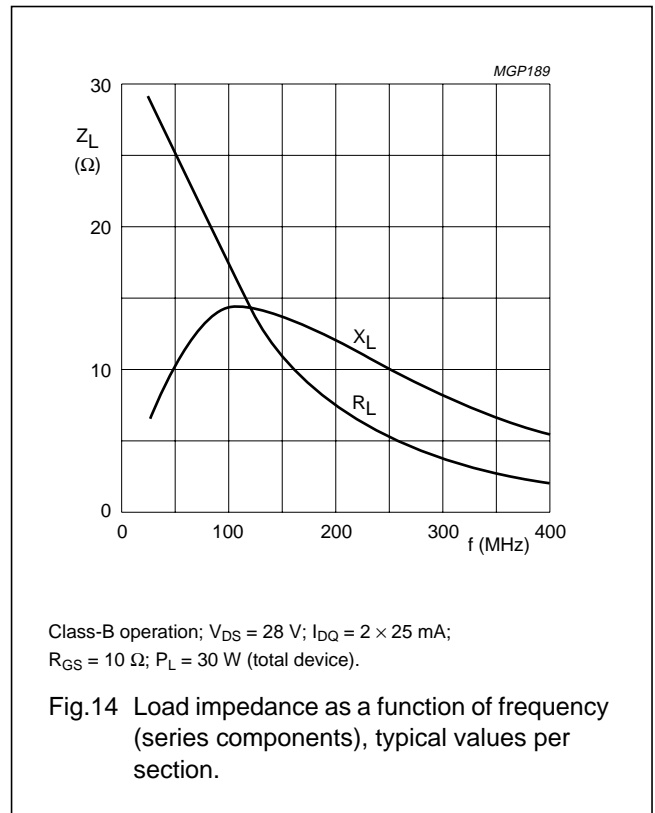
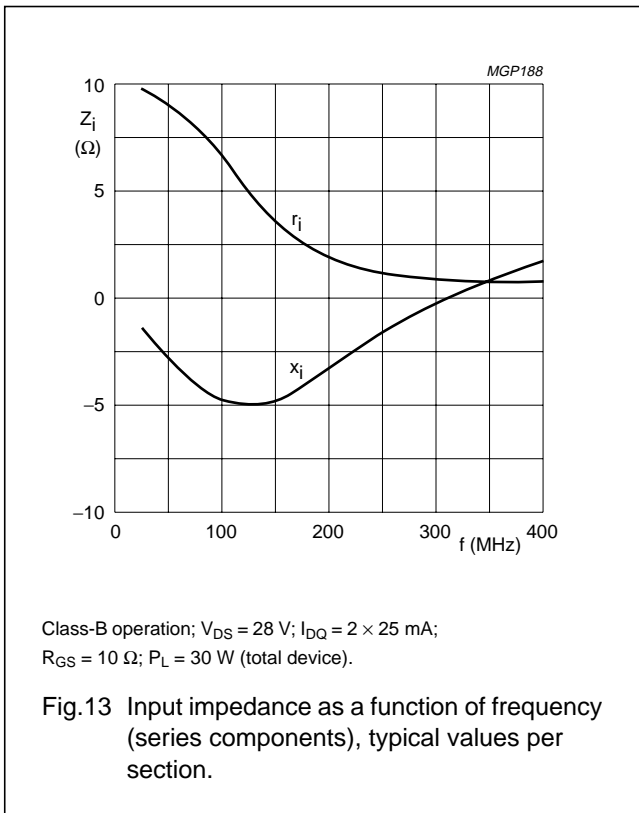

VHF push-pull power MOS transistor

BLF245B

PACKAGE OUTLINE

Flanged double-ended ceramic package; 2 mounting holes; 4 leads

SOT279A

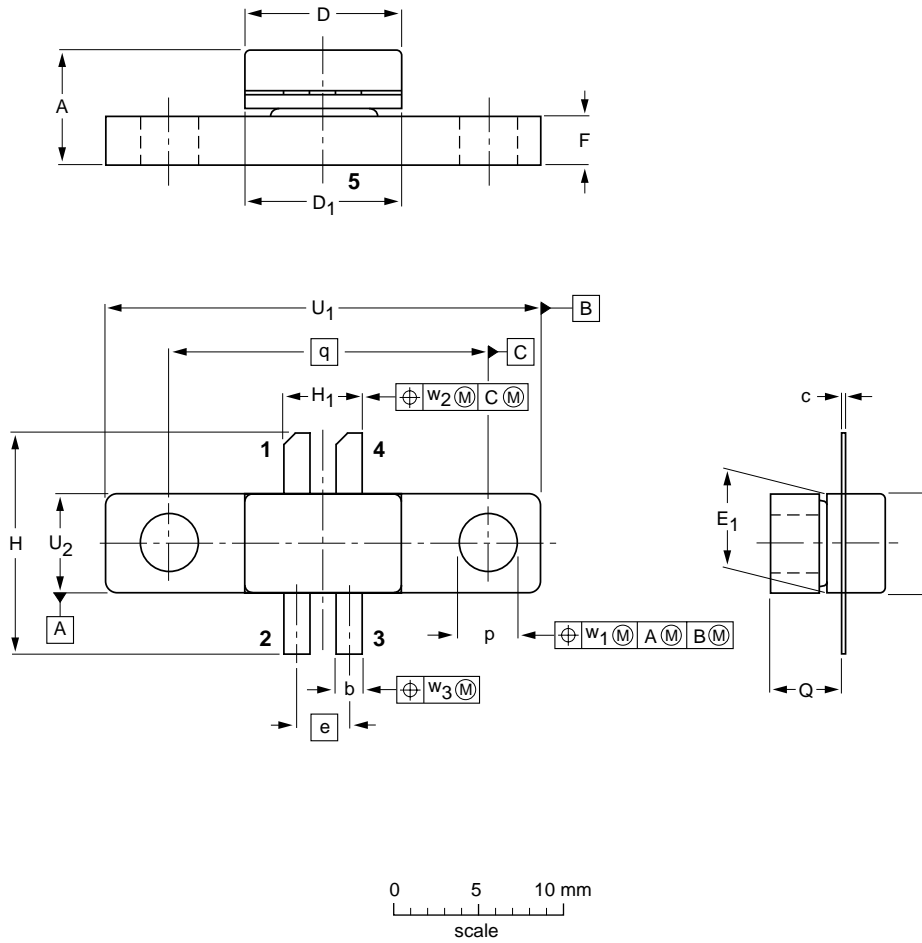

DIMENSIONS (millimetre dimensions are derived from the original inch dimensions)

UNIT	A	b	c	D	D <sub>1</sub>	E	E <sub>1</sub>	e	F	H	H <sub>1</sub>	p	Q	q	U <sub>1</sub>	U <sub>2</sub>	w <sub>1</sub>	w <sub>2</sub>	w <sub>3</sub>
mm	6.84 6.01	1.65 1.40	0.15 0.10	9.25 9.04	9.27 9.02	5.94 5.74	5.97 5.72	3.05	3.05 2.54	12.96 11.94	4.96 4.19	3.48 3.23	4.34 4.04	18.42	24.90 24.64	5.97 5.72	0.25	0.51	0.25
inches	0.269 0.237	0.065 0.055	0.006 0.004	0.364 0.356	0.365 0.355	0.234 0.226	0.235 0.225	0.120	0.120 0.100	0.510 0.470	0.195 0.165	0.137 0.127	0.171 0.159	0.725	0.980 0.970	0.235 0.225	0.010	0.020	0.010

OUTLINE VERSION	REFERENCES				EUROPEAN PROJECTION	ISSUE DATE
	IEC	JEDEC	EIAJ			
SOT279A						99-03-29

## VHF push-pull power MOS transistor

BLF245B

## DATA SHEET STATUS

DATA SHEET STATUS	PRODUCT STATUS	DEFINITIONS <sup>(1)</sup>
Objective specification	Development	This data sheet contains the design target or goal specifications for product development. Specification may change in any manner without notice.
Preliminary specification	Qualification	This data sheet contains preliminary data, and supplementary data will be published at a later date. Philips Semiconductors reserves the right to make changes at any time without notice in order to improve design and supply the best possible product.
Product specification	Production	This data sheet contains final specifications. Philips Semiconductors reserves the right to make changes at any time without notice in order to improve design and supply the best possible product.

## Note

1. Please consult the most recently issued data sheet before initiating or completing a design.

## DEFINITIONS

**Short-form specification** — The data in a short-form specification is extracted from a full data sheet with the same type number and title. For detailed information see the relevant data sheet or data handbook.

**Limiting values definition** — Limiting values given are in accordance with the Absolute Maximum Rating System (IEC 60134). Stress above one or more of the limiting values may cause permanent damage to the device. These are stress ratings only and operation of the device at these or at any other conditions above those given in the Characteristics sections of the specification is not implied. Exposure to limiting values for extended periods may affect device reliability.

**Application information** — Applications that are described herein for any of these products are for illustrative purposes only. Philips Semiconductors make no representation or warranty that such applications will be suitable for the specified use without further testing or modification.

## DISCLAIMERS

**Life support applications** — These products are not designed for use in life support appliances, devices, or systems where malfunction of these products can reasonably be expected to result in personal injury. Philips Semiconductors customers using or selling these products for use in such applications do so at their own risk and agree to fully indemnify Philips Semiconductors for any damages resulting from such application.

**Right to make changes** — Philips Semiconductors reserves the right to make changes, without notice, in the products, including circuits, standard cells, and/or software, described or contained herein in order to improve design and/or performance. Philips Semiconductors assumes no responsibility or liability for the use of any of these products, conveys no licence or title under any patent, copyright, or mask work right to these products, and makes no representations or warranties that these products are free from patent, copyright, or mask work right infringement, unless otherwise specified.

VHF push-pull power MOS transistor

BLF245B

---

**NOTES**

VHF push-pull power MOS transistor

BLF245B

---

**NOTES**

VHF push-pull power MOS transistor

BLF245B

---

**NOTES**

# Philips Semiconductors – a worldwide company

**Argentina:** see South America

**Australia:** 3 Figtree Drive, HOMEBUSH, NSW 2140,  
Tel. +61 2 9704 8141, Fax. +61 2 9704 8139

**Austria:** Computerstr. 6, A-1101 WIEN, P.O. Box 213,  
Tel. +43 1 60 101 1248, Fax. +43 1 60 101 1210

**Belarus:** Hotel Minsk Business Center, Bld. 3, r. 1211, Volodarski Str. 6,  
220050 MINSK, Tel. +375 172 20 0733, Fax. +375 172 20 0773

**Belgium:** see The Netherlands

**Brazil:** see South America

**Bulgaria:** Philips Bulgaria Ltd., Energoproject, 15th floor,  
51 James Bourchier Blvd., 1407 SOFIA,  
Tel. +359 2 68 9211, Fax. +359 2 68 9102

**Canada:** PHILIPS SEMICONDUCTORS/COMPONENTS,  
Tel. +1 800 234 7381, Fax. +1 800 943 0087

**China/Hong Kong:** 501 Hong Kong Industrial Technology Centre,  
72 Tat Chee Avenue, Kowloon Tong, HONG KONG,  
Tel. +852 2319 7888, Fax. +852 2319 7700

**Colombia:** see South America

**Czech Republic:** see Austria

**Denmark:** Sydhavnsgade 23, 1780 COPENHAGEN V,  
Tel. +45 33 29 3333, Fax. +45 33 29 3905

**Finland:** Sinikalliontie 3, FIN-02630 ESPOO,  
Tel. +358 9 615 800, Fax. +358 9 6158 0920

**France:** 51 Rue Carnot, BP317, 92156 SURESNES Cedex,  
Tel. +33 1 4099 6161, Fax. +33 1 4099 6427

**Germany:** Hammerbrookstraße 69, D-20097 HAMBURG,  
Tel. +49 40 2353 60, Fax. +49 40 2353 6300

**Hungary:** see Austria

**India:** Philips INDIA Ltd, Band Box Building, 2nd floor,  
254-D, Dr. Annie Besant Road, Worli, MUMBAI 400 025,  
Tel. +91 22 493 8541, Fax. +91 22 493 0966

**Indonesia:** PT Philips Development Corporation, Semiconductors Division,  
Gedung Philips, Jl. Buncit Raya Kav.99-100, JAKARTA 12510,  
Tel. +62 21 794 0040 ext. 2501, Fax. +62 21 794 0080

**Ireland:** Newstead, Clonskeagh, DUBLIN 14,  
Tel. +353 1 7640 000, Fax. +353 1 7640 200

**Israel:** RAPAC Electronics, 7 Kehilat Saloniki St, PO Box 18053,  
TEL AVIV 61180, Tel. +972 3 645 0444, Fax. +972 3 649 1007

**Italy:** PHILIPS SEMICONDUCTORS, Via Casati, 23 - 20052 MONZA (MI),  
Tel. +39 039 203 6838, Fax +39 039 203 6800

**Japan:** Philips Bldg 13-37, Kohnan 2-chome, Minato-ku,  
TOKYO 108-8507, Tel. +81 3 3740 5130, Fax. +81 3 3740 5057

**Korea:** Philips House, 260-199 Itaewon-dong, Yongsan-ku, SEOUL,  
Tel. +82 2 709 1412, Fax. +82 2 709 1415

**Malaysia:** No. 76 Jalan Universiti, 46200 PETALING JAYA, SELANGOR,  
Tel. +60 3 750 5214, Fax. +60 3 757 4880

**Mexico:** 5900 Gateway East, Suite 200, EL PASO, TEXAS 79905,  
Tel. +9-5 800 234 7381, Fax +9-5 800 943 0087

**Middle East:** see Italy

**Netherlands:** Postbus 90050, 5600 PB EINDHOVEN, Bldg. VB,  
Tel. +31 40 27 82785, Fax. +31 40 27 88399

**New Zealand:** 2 Wagener Place, C.P.O. Box 1041, AUCKLAND,  
Tel. +64 9 849 4160, Fax. +64 9 849 7811

**Norway:** Box 1, Manglerud 0612, OSLO,  
Tel. +47 22 74 8000, Fax. +47 22 74 8341

**Pakistan:** see Singapore

**Philippines:** Philips Semiconductors Philippines Inc.,  
106 Valero St. Salcedo Village, P.O. Box 2108 MCC, MAKATI,  
Metro MANILA, Tel. +63 2 816 6380, Fax. +63 2 817 3474

**Poland:** Al.Jerozolimskie 195 B, 02-222 WARSAW,  
Tel. +48 22 5710 000, Fax. +48 22 5710 001

**Portugal:** see Spain

**Romania:** see Italy

**Russia:** Philips Russia, Ul. Usatcheva 35A, 119048 MOSCOW,  
Tel. +7 095 755 6918, Fax. +7 095 755 6919

**Singapore:** Lorong 1, Toa Payoh, SINGAPORE 319762,  
Tel. +65 350 2538, Fax. +65 251 6500

**Slovakia:** see Austria

**Slovenia:** see Italy

**South Africa:** S.A. PHILIPS Pty Ltd., 195-215 Main Road Martindale,  
2092 JOHANNESBURG, P.O. Box 58088 Newville 2114,  
Tel. +27 11 471 5401, Fax. +27 11 471 5398

**South America:** Al. Vicente Pinzon, 173, 6th floor,  
04547-130 SÃO PAULO, SP, Brazil,  
Tel. +55 11 821 2333, Fax. +55 11 821 2382

**Spain:** Balmes 22, 08007 BARCELONA,  
Tel. +34 93 301 6312, Fax. +34 93 301 4107

**Sweden:** Kottbygatan 7, Akalla, S-16485 STOCKHOLM,  
Tel. +46 8 5985 2000, Fax. +46 8 5985 2745

**Switzerland:** Allmendstrasse 140, CH-8027 ZÜRICH,  
Tel. +41 1 488 2741 Fax. +41 1 488 3263

**Taiwan:** Philips Semiconductors, 5F, No. 96, Chien Kuo N. Rd., Sec. 1,  
TAIPEI, Taiwan Tel. +886 2 2134 2451, Fax. +886 2 2134 2874

**Thailand:** PHILIPS ELECTRONICS (THAILAND) Ltd.,  
60/14 MOO 11, Bangna Trad Road KM. 3, Bagna, BANGKOK 10260,  
Tel. +66 2 361 7910, Fax. +66 2 398 3447

**Turkey:** Yukari Dudullu, Org. San. Blg., 2.Cad. Nr. 28 81260 Umraniye,  
ISTANBUL, Tel. +90 216 522 1500, Fax. +90 216 522 1813

**Ukraine:** PHILIPS UKRAINE, 4 Patrice Lumumba str., Building B, Floor 7,  
252042 KIEV, Tel. +380 44 264 2776, Fax. +380 44 268 0461

**United Kingdom:** Philips Semiconductors Ltd., 276 Bath Road, Hayes,  
MIDDLESEX UB3 5BX, Tel. +44 208 730 5000, Fax. +44 208 754 8421

**United States:** 811 East Arques Avenue, SUNNYVALE, CA 94088-3409,  
Tel. +1 800 234 7381, Fax. +1 800 943 0087

**Uruguay:** see South America

**Vietnam:** see Singapore

**Yugoslavia:** PHILIPS, Trg N. Pasica 5/v, 11000 BEOGRAD,  
Tel. +381 11 3341 299, Fax.+381 11 3342 553

**For all other countries apply to:** Philips Semiconductors,  
Marketing Communications, Building BE-p, P.O. Box 218, 5600 MD EINDHOVEN,  
The Netherlands, Fax. +31 40 27 24825

**Internet:** <http://www.semiconductors.philips.com>

© Philips Electronics N.V. 2000

SCA 70

All rights are reserved. Reproduction in whole or in part is prohibited without the prior written consent of the copyright owner.

The information presented in this document does not form part of any quotation or contract, is believed to be accurate and reliable and may be changed without notice. No liability will be accepted by the publisher for any consequence of its use. Publication thereof does not convey nor imply any license under patent- or other industrial or intellectual property rights.

Printed in The Netherlands

613524/05/pp16

Date of release: 2000 Oct 17

Document order number: 9397 750 07432

*Let's make things better.*

**Philips**  
Semiconductors



**PHILIPS**