

# DATA SHEET

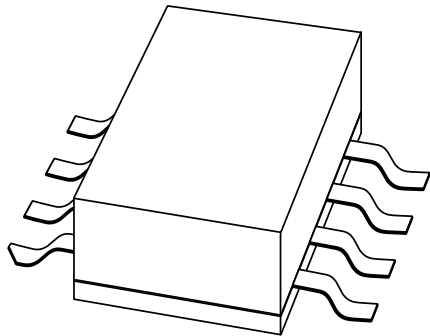

## **BLF404** UHF power MOS transistor

Product specification  
Supersedes data of 1997 Oct 28

1998 Jan 29

# UHF power MOS transistor

# BLF404

### FEATURES

- High power gain
- Easy power control
- Gold metallization
- Good thermal stability
- Withstands full load mismatch
- Designed for broadband operation.

### APPLICATIONS

- Communication transmitters in the VHF/UHF range with a nominal supply voltage of 12.5 V.

### DESCRIPTION

Silicon N-channel enhancement mode vertical D-MOS power transistor in an 8-lead SOT409A SMD package with a ceramic cap.

### PINNING

PIN	DESCRIPTION
1, 8	source
2, 3	gate
4, 5	source
6, 7	drain

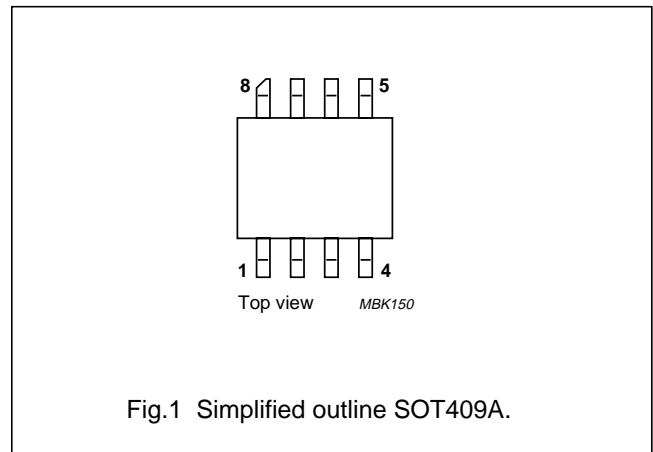

### QUICK REFERENCE DATA

RF performance at  $T_{mb} \leq 60 \text{ }^\circ\text{C}$  in a common source test circuit.

MODE OF OPERATION	f (MHz)	V <sub>DS</sub> (V)	P <sub>L</sub> (W)	G <sub>p</sub> (dB)	$\eta_D$ (%)
CW class-AB	500	12.5	4	$\geq 10$	$\geq 50$

**CAUTION**

This product is supplied in anti-static packing to prevent damage caused by electrostatic discharge during transport and handling. For further information, refer to Philips specs.: SNW-EQ-608, SNW-FQ-302A, and SNW-FQ-302B.

# UHF power MOS transistor

BLF404

## LIMITING VALUES

In accordance with the Absolute Maximum Rating System (IEC 134).

SYMBOL	PARAMETER	CONDITIONS	MIN.	MAX.	UNIT
$V_{DS}$	drain-source voltage		–	40	V
$V_{GS}$	gate-source voltage		–	$\pm 20$	V
$I_D$	DC drain current		–	1.5	A
$P_{tot}$	total power dissipation	$T_{mb} \leq 85\text{ }^\circ\text{C}$	–	8.3	W
$T_{stg}$	storage temperature		–65	150	$^\circ\text{C}$
$T_j$	junction temperature		–	200	$^\circ\text{C}$

## THERMAL CHARACTERISTICS

SYMBOL	PARAMETER	CONDITIONS	VALUE	UNIT
$R_{th\ j-mb}$	thermal resistance from junction to mounting base	$T_{mb} \leq 85\text{ }^\circ\text{C}$ , $P_{tot} = 8.3\text{ W}$	12.1	K/W

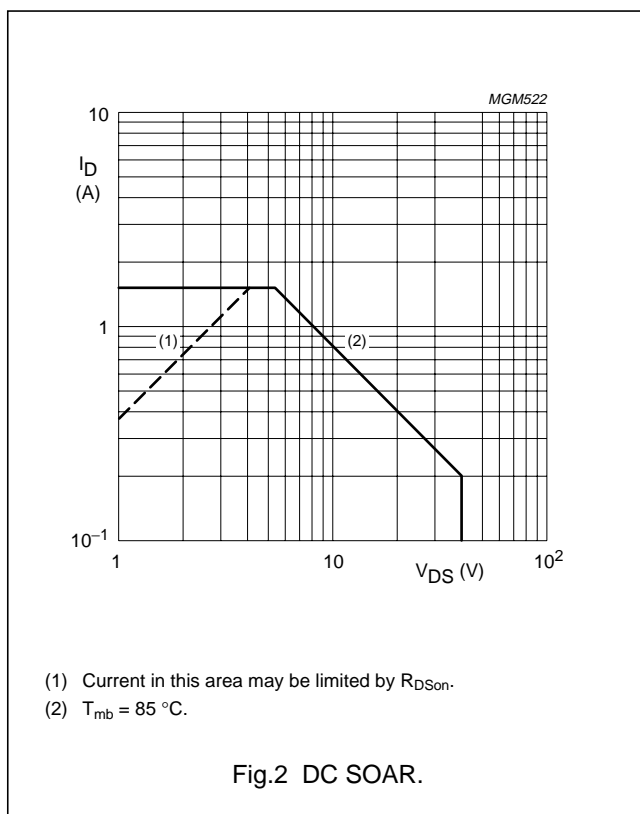

UHF power MOS transistor

BLF404

**CHARACTERISTICS**

$T_j = 25\text{ }^\circ\text{C}$  unless otherwise specified.

SYMBOL	PARAMETER	CONDITIONS	MIN.	TYP.	MAX.	UNIT
$V_{(BR)DSS}$	drain-source breakdown voltage	$V_{GS} = 0; I_D = 5\text{ mA}$	40	–	–	V
$V_{GS(th)}$	gate-source threshold voltage	$I_D = 50\text{ mA}; V_{DS} = 10\text{ V}$	2	–	4.5	V
$I_{DSS}$	drain-source leakage current	$V_{GS} = 0; V_{DS} = 12.5\text{ V}$	–	–	0.5	mA
$I_{GSS}$	gate-source leakage current	$V_{DS} = 0; V_{GS} = \pm 20\text{ V}$	–	–	1	$\mu\text{A}$
$I_{DSX}$	on-state drain current	$V_{GS} = 15\text{ V}; V_{DS} = 10\text{ V}$	–	2.3	–	A
$R_{DSon}$	drain-source on-state resistance	$I_D = 0.7\text{ A}; V_{GS} = 15\text{ V}$	–	1.8	2.7	$\Omega$
$g_{fs}$	forward transconductance	$I_D = 0.7\text{ A}; V_{DS} = 10\text{ V}$	200	270	–	mS
$C_{is}$	input capacitance	$V_{GS} = 0; V_{DS} = 12.5\text{ V}; f = 1\text{ MHz}$	–	14	–	pF
$C_{os}$	output capacitance	$V_{GS} = 0; V_{DS} = 12.5\text{ V}; f = 1\text{ MHz}$	–	17	–	pF
$C_{rs}$	feedback capacitance	$V_{GS} = 0; V_{DS} = 12.5\text{ V}; f = 1\text{ MHz}$	–	3	–	pF

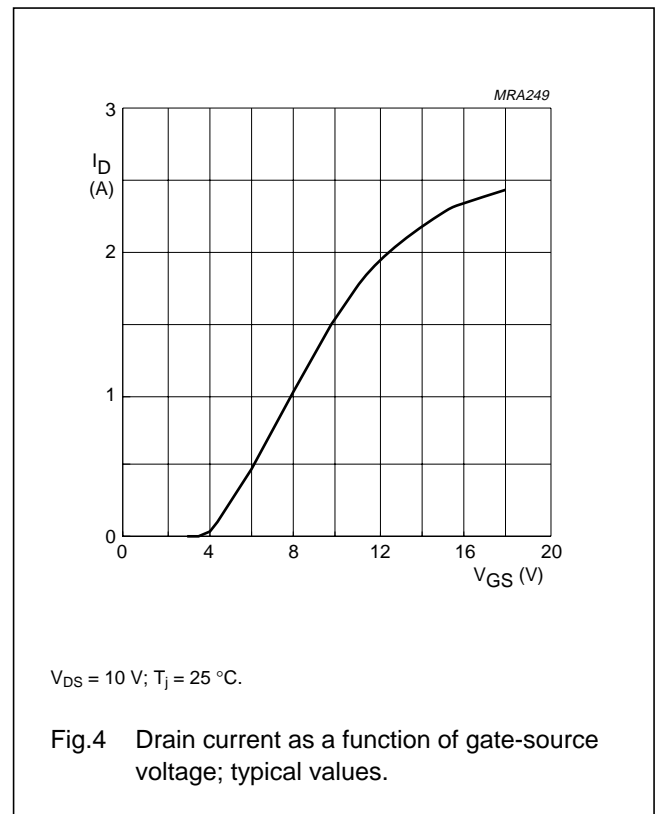
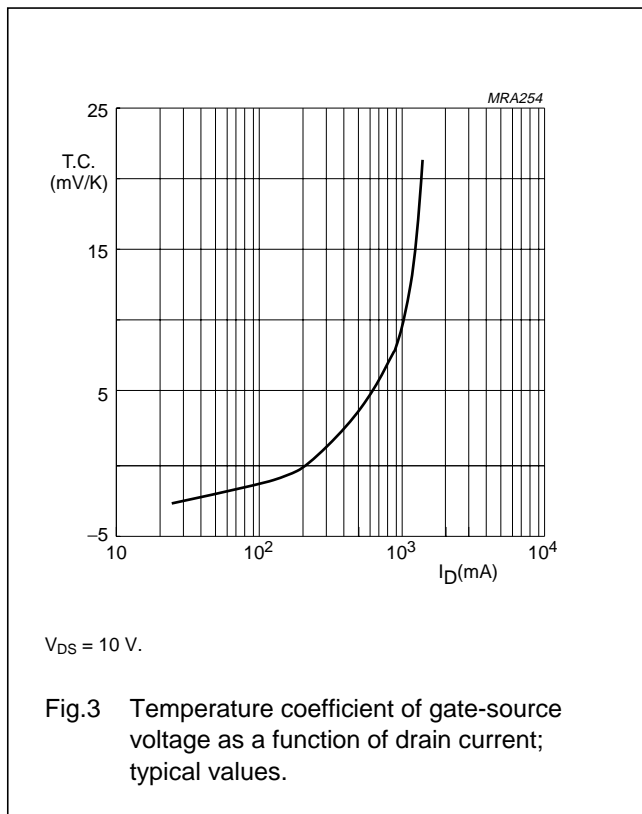

UHF power MOS transistor

BLF404

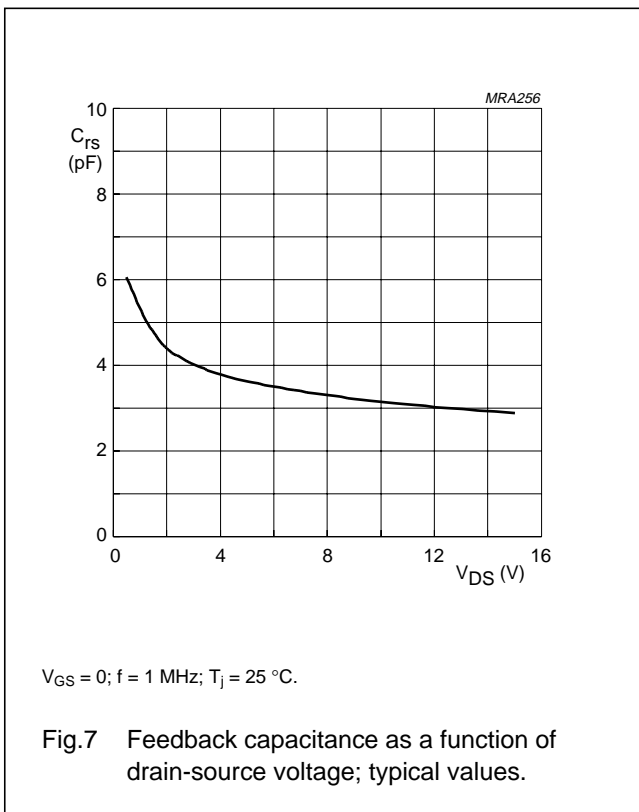
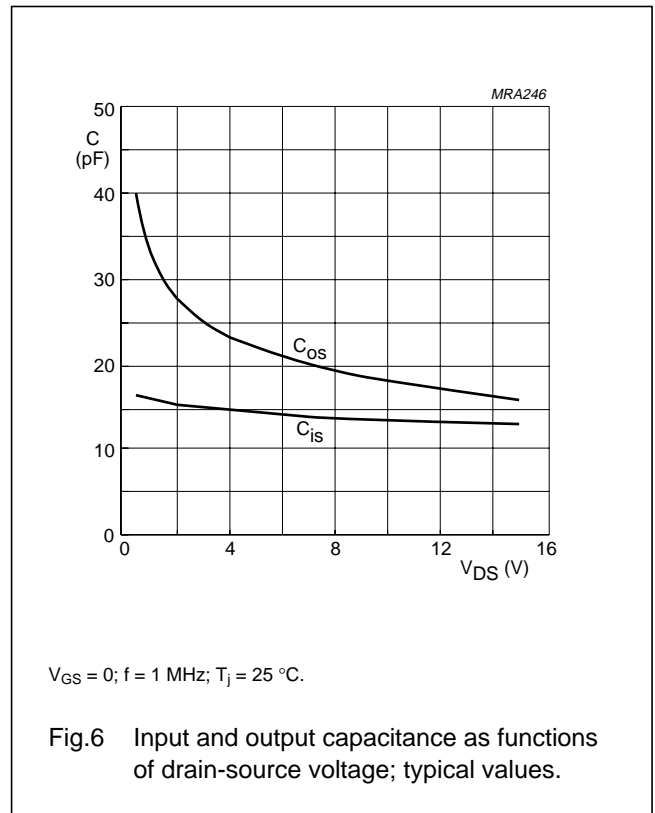
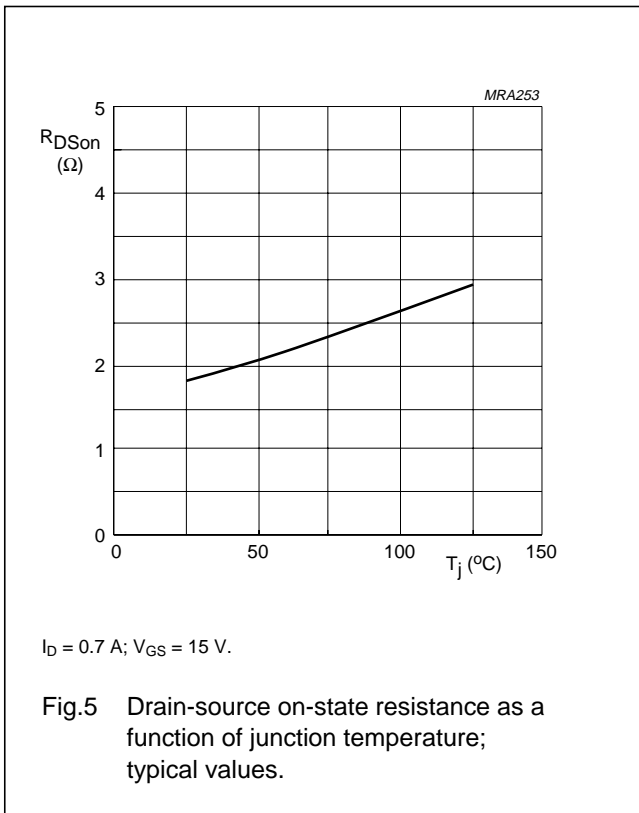

UHF power MOS transistor

BLF404

**APPLICATION INFORMATION**

RF performance at  $T_{mb} \leq 60\text{ }^\circ\text{C}$  in a common source test circuit with the device soldered on a printed-circuit board with through metallized holes.

MODE OF OPERATION	f (MHz)	V <sub>DS</sub> (V)	I <sub>DQ</sub> (A)	P <sub>L</sub> (W)	G <sub>p</sub> (dB)	$\eta_D$ (%)
CW, class-AB	500	12.5	50	4	$\geq 10$ typ. 11.5	$\geq 50$ typ. 55

**Ruggedness in class-AB operation**

The BLF404 is capable of withstanding a load mismatch corresponding to VSWR = 10 : 1 through all phases under the following conditions: f = 500 MHz; V<sub>DS</sub> = 12.5 V; P<sub>L</sub> = 4 W; T<sub>mb</sub> ≤ 60 °C.

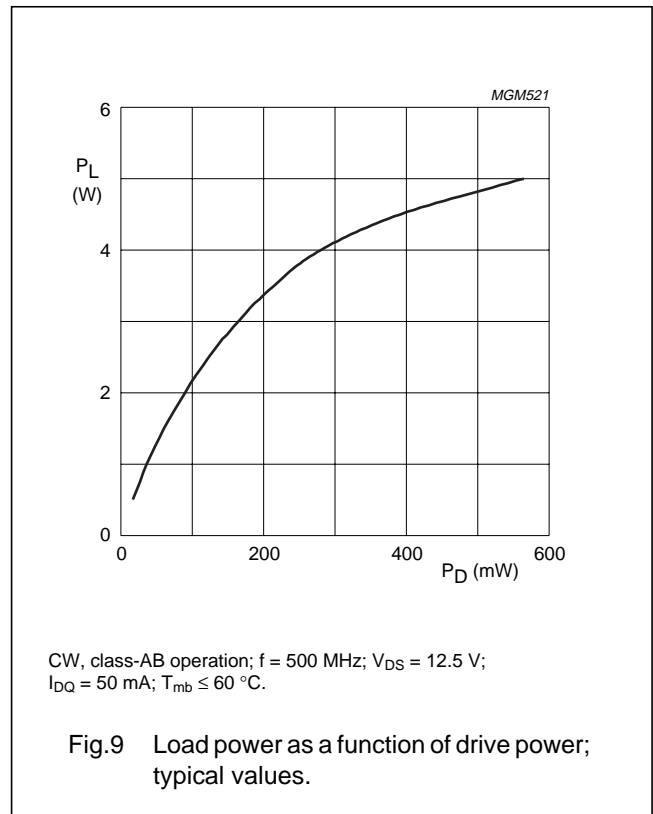
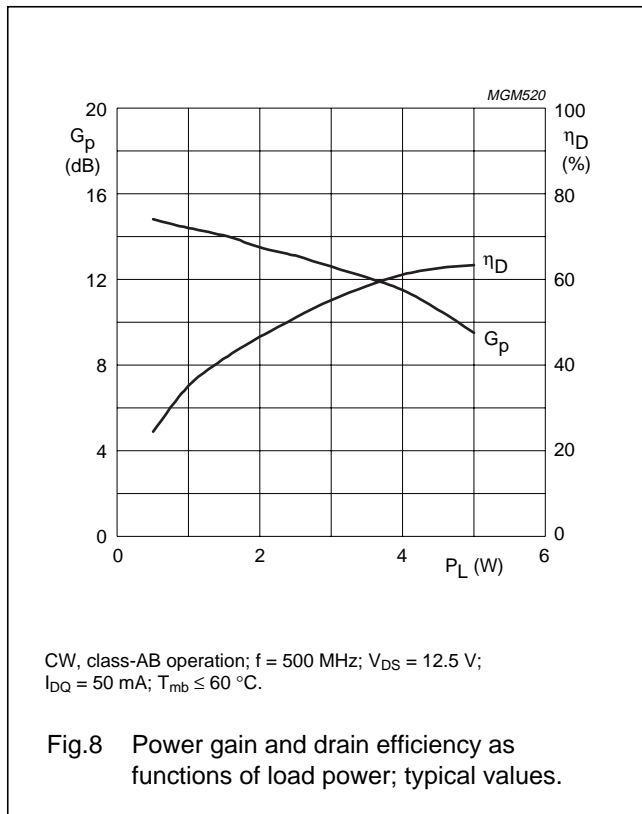

# UHF power MOS transistor

# BLF404

## Test circuit information

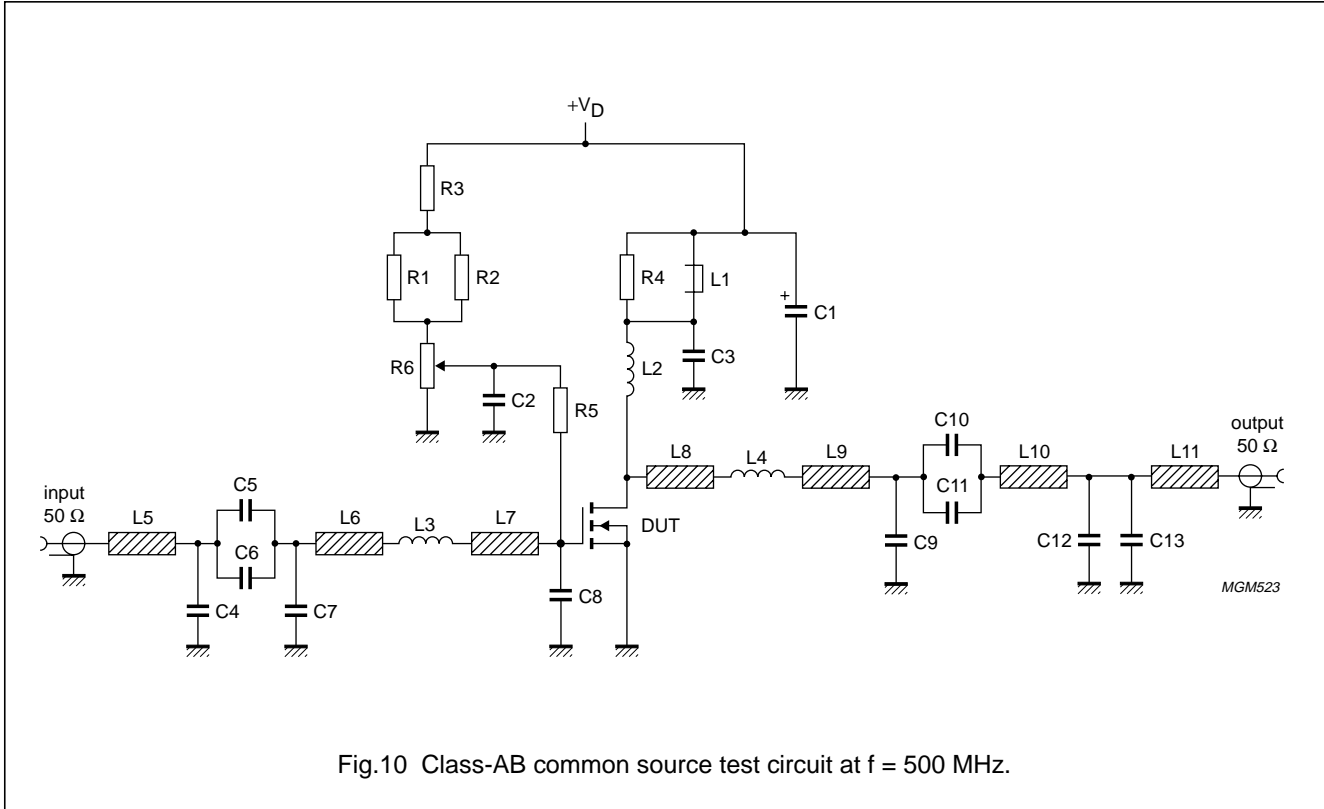

Fig.10 Class-AB common source test circuit at  $f = 500$  MHz.

## UHF power MOS transistor

BLF404

List of components used in test circuit (see Figs 10 and 11).

COMPONENT	DESCRIPTION	VALUE	DIMENSIONS	CATALOGUE No.
C1	electrolytic capacitor	4.7 $\mu$ F, 10 V		
C2, C3	multilayer ceramic chip capacitor	47 nF		
C4	multilayer ceramic chip capacitor; note 1	18 pF		
C5, C10	multilayer ceramic chip capacitor; note 1	180 pF		
C6, C11	multilayer ceramic chip capacitor; note 1	270 pF		
C7	multilayer ceramic chip capacitor; note 1	22 pF		
C8	multilayer ceramic chip capacitor; note 1	8.2 pF		
C9	multilayer ceramic chip capacitor; note 1	2.7 pF		
C12	multilayer ceramic chip capacitor; note 1	1.2 pF		
C13	multilayer ceramic chip capacitor; note 1	12 pF		
L1	2 turns 1 mm enamelled copper wire on a grade 4B1 Ferroxcube core		ext. dia. = 4.2 mm int. dia. = 2 mm length = 6 mm	
L2	3 turns 1 mm enamelled copper wire		int. dia. = 4.6 mm leads = 2 x 5 mm	
L3	bifilar coil		lead dia. = 0.8 mm	
L4	bifilar coil		lead dia. = 1 mm	
L5	stripline; note 2	50 $\Omega$	8.8 x 2.38 mm	
L6	stripline; note 2	50 $\Omega$	5.8 x 2.38 mm	
L7	stripline; note 2	50 $\Omega$	6.8 x 2.38 mm	
L8	stripline; note 2	50 $\Omega$	3.76 x 2.38 mm	
L9	stripline; note 2	50 $\Omega$	5.8 x 2.38 mm	
L10	stripline; note 2	50 $\Omega$	4.48 x 2.38 mm	
L11	stripline; note 2	50 $\Omega$	3.13 x 2.38 mm	
R1, R2	SMD resistor	3.9 k $\Omega$		
R3	metal film resistor	1 k $\Omega$ , 0.25 W		
R4	metal film resistor	22 $\Omega$ , 0.25 W		
R5	metal film resistor	10 k $\Omega$ , 0.25 W		
R6	potentiometer	10 k $\Omega$		

**Notes**

- American Technical Ceramics type 100A or capacitor of same quality.
- The striplines are on a double copper-clad printed circuit board, with DUROID dielectric ( $\epsilon_r = 2.2$ ); thickness 0.79 mm, thickness of the copper sheet 2 x 35  $\mu$ m.



UHF power MOS transistor

BLF404

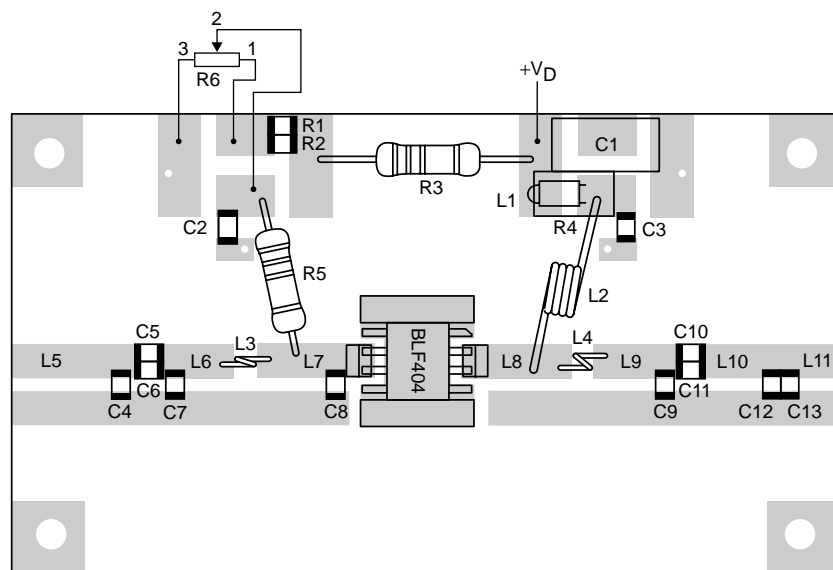
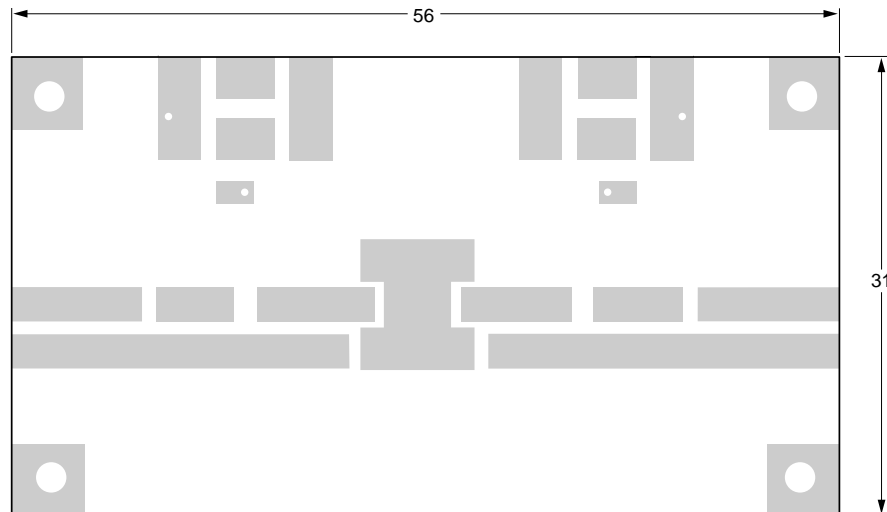

MGM524

Dimensions in mm.

The components are situated on one side of the copper-clad printed-circuit board, the other side is unetched and serves as a ground plane. Earth connections from the component side to the ground plane are made by through metallization.

Fig.11 Printed-circuit board and component layout for 500 MHz class-AB test circuit in Fig.10.

UHF power MOS transistor

BLF404

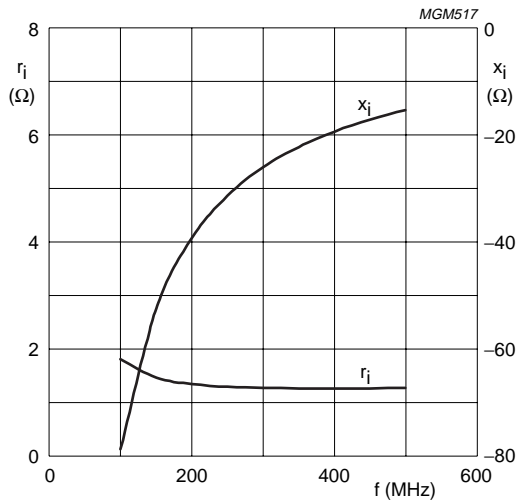

CW, class-AB operation;  $V_{DS} = 12.5$  V;  $I_D = 50$  mA;  
 $P_L = 4$  W;  $T_{mb} \leq 60$  °C.

Fig. 12 Input impedance as a function of frequency (series components); typical values.

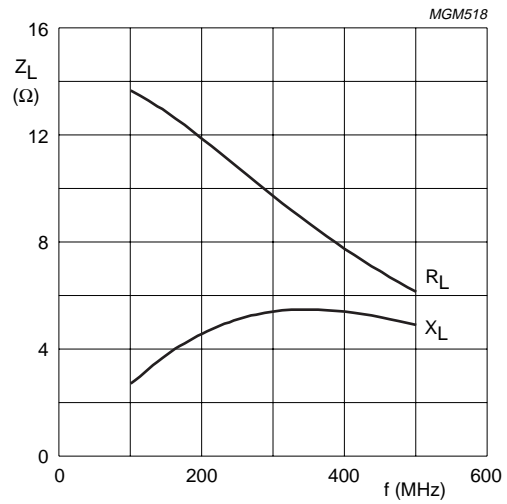

CW, class-AB operation;  $V_{DS} = 12.5$  V;  $I_D = 50$  mA;  
 $P_L = 4$  W;  $T_{mb} \leq 60$  °C.

Fig. 13 Load impedance as a function of frequency (series components); typical values.

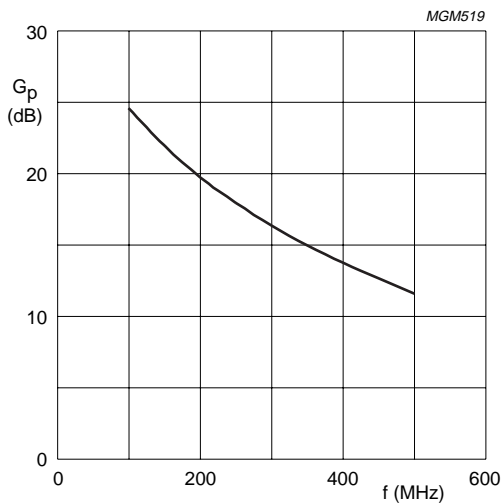

CW, class-AB operation;  $V_{DS} = 12.5$  V;  $I_{DQ} = 50$  mA;  
 $P_L = 4$  W;  $T_{mb} \leq 60$  °C.

Fig. 14 Power gain as a function of frequency (series components); typical values.

UHF power MOS transistor

BLF404

**MOUNTING RECOMMENDATIONS**

Both the metallized groundplate and leads contribute to the heatflow. It is recommended that the transistor is mounted on a grounded metallized area of a maximum thickness of 0.8 mm on the printed-circuit board, equipped with at least 12 (0.5 mm diameter) through metallized holes filled with solder.

A thermal resistance  $R_{th(mb-h)}$  of 5 K/W can be achieved if heatsink compound is applied when the transistor is mounted on the printed-circuit board.

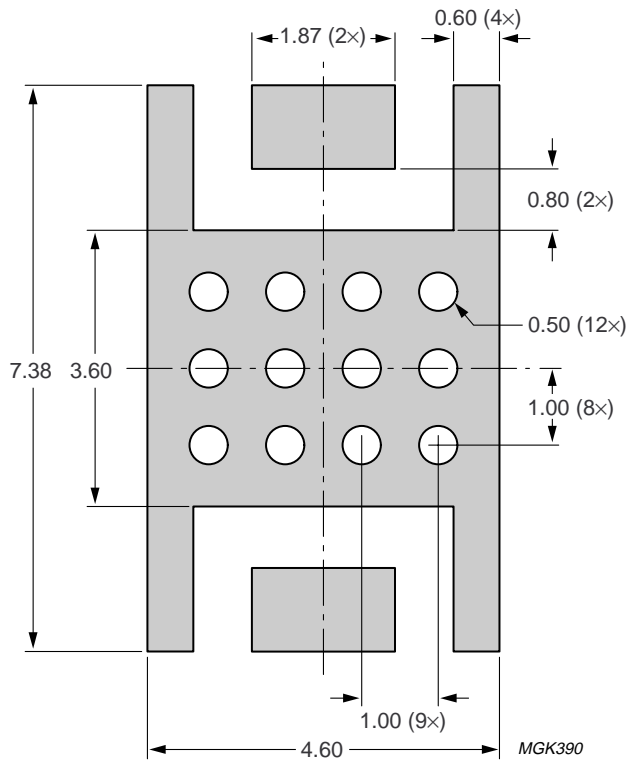

Dimensions in mm.

Fig.15 Reflow soldering footprint for SOT409A.

UHF power MOS transistor

BLF404

PACKAGE OUTLINE

Ceramic surface mounted package; 8 leads

SOT409A

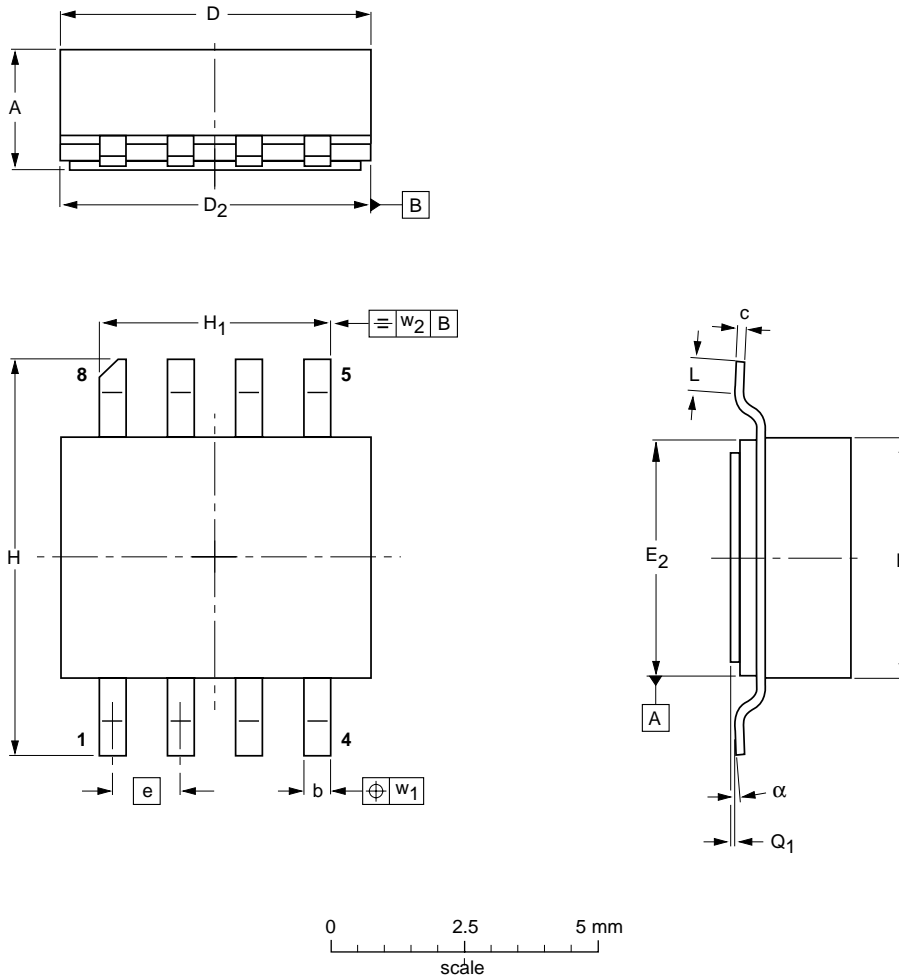

DIMENSIONS (millimetre dimensions are derived from the original inch dimensions)

UNIT	A	b	c	D	D <sub>2</sub>	E	E <sub>2</sub>	e	H	H <sub>1</sub>	L	Q <sub>1</sub>	w <sub>1</sub>	w <sub>2</sub>	α
mm	2.36 2.06	0.58 0.43	0.23 0.18	5.94 5.03	5.16 5.00	4.93 4.01	4.14 3.99	1.27	7.47 7.26	4.39 4.24	1.02 0.51	0.10 0.00	0.25	0.25	7° 0°
inches	0.093 0.081	0.023 0.017	0.009 0.007	0.234 0.198	0.203 0.197	0.194 0.158	0.163 0.157	0.050	0.294 0.286	0.173 0.167	0.040 0.020	0.004 0.000	0.010	0.010	7° 0°

OUTLINE VERSION	REFERENCES				EUROPEAN PROJECTION	ISSUE DATE
	IEC	JEDEC	EIAJ			
SOT409A						98-01-27

## UHF power MOS transistor

BLF404

**DEFINITIONS**

<b>Data Sheet Status</b>	
Objective specification	This data sheet contains target or goal specifications for product development.
Preliminary specification	This data sheet contains preliminary data; supplementary data may be published later.
Product specification	This data sheet contains final product specifications.
<b>Limiting values</b>	
Limiting values given are in accordance with the Absolute Maximum Rating System (IEC 134). Stress above one or more of the limiting values may cause permanent damage to the device. These are stress ratings only and operation of the device at these or at any other conditions above those given in the Characteristics sections of the specification is not implied. Exposure to limiting values for extended periods may affect device reliability.	
<b>Application information</b>	
Where application information is given, it is advisory and does not form part of the specification.	

**LIFE SUPPORT APPLICATIONS**

These products are not designed for use in life support appliances, devices, or systems where malfunction of these products can reasonably be expected to result in personal injury. Philips customers using or selling these products for use in such applications do so at their own risk and agree to fully indemnify Philips for any damages resulting from such improper use or sale.

UHF power MOS transistor

BLF404

---

**NOTES**

UHF power MOS transistor

BLF404

---

**NOTES**

# Philips Semiconductors – a worldwide company

**Argentina:** see South America

**Australia:** 34 Waterloo Road, NORTH RYDE, NSW 2113,  
Tel. +61 2 9805 4455, Fax. +61 2 9805 4466

**Austria:** Computerstr. 6, A-1101 WIEN, P.O. Box 213, Tel. +43 160 1010,  
Fax. +43 160 101 1210

**Belarus:** Hotel Minsk Business Center, Bld. 3, r. 1211, Volodarski Str. 6,  
220050 MINSK, Tel. +375 172 200 733, Fax. +375 172 200 773

**Belgium:** see The Netherlands

**Brazil:** see South America

**Bulgaria:** Philips Bulgaria Ltd., Energoproject, 15th floor,  
51 James Bourchier Blvd., 1407 SOFIA,  
Tel. +359 2 689 211, Fax. +359 2 689 102

**Canada:** PHILIPS SEMICONDUCTORS/COMPONENTS,  
Tel. +1 800 234 7381

**China/Hong Kong:** 501 Hong Kong Industrial Technology Centre,  
72 Tat Chee Avenue, Kowloon Tong, HONG KONG,  
Tel. +852 2319 7888, Fax. +852 2319 7700

**Colombia:** see South America

**Czech Republic:** see Austria

**Denmark:** Prags Boulevard 80, PB 1919, DK-2300 COPENHAGEN S,  
Tel. +45 32 88 2636, Fax. +45 31 57 0044

**Finland:** Sinikalliontie 3, FIN-02630 ESPOO,  
Tel. +358 9 615800, Fax. +358 9 61580920

**France:** 51 Rue Carnot, BP317, 92156 SURESNES Cedex,  
Tel. +33 1 40 99 6161, Fax. +33 1 40 99 6427

**Germany:** Hammerbrookstraße 69, D-20097 HAMBURG,  
Tel. +49 40 23 53 60, Fax. +49 40 23 536 300

**Greece:** No. 15, 25th March Street, GR 17778 TAVROS/ATHENS,  
Tel. +30 1 4894 339/239, Fax. +30 1 4814 240

**Hungary:** see Austria

**India:** Philips INDIA Ltd, Band Box Building, 2nd floor,  
254-D, Dr. Annie Besant Road, Worli, MUMBAI 400 025,  
Tel. +91 22 493 8541, Fax. +91 22 493 0966

**Indonesia:** see Singapore

**Ireland:** Newstead, Clonskeagh, DUBLIN 14,  
Tel. +353 1 7640 000, Fax. +353 1 7640 200

**Israel:** RAPAC Electronics, 7 Kehilat Saloniki St, PO Box 18053,  
TEL AVIV 61180, Tel. +972 3 645 0444, Fax. +972 3 649 1007

**Italy:** PHILIPS SEMICONDUCTORS, Piazza IV Novembre 3,  
20124 MILANO, Tel. +39 2 6752 2531, Fax. +39 2 6752 2557

**Japan:** Philips Bldg 13-37, Kohnan 2-chome, Minato-ku, TOKYO 108,  
Tel. +81 3 3740 5130, Fax. +81 3 3740 5077

**Korea:** Philips House, 260-199 Itaewon-dong, Yongsan-ku, SEOUL,  
Tel. +82 2 709 1412, Fax. +82 2 709 1415

**Malaysia:** No. 76 Jalan Universiti, 46200 PETALING JAYA, SELANGOR,  
Tel. +60 3 750 5214, Fax. +60 3 757 4880

**Mexico:** 5900 Gateway East, Suite 200, EL PASO, TEXAS 79905,  
Tel. +9-5 800 234 7381

**Middle East:** see Italy

**Netherlands:** Postbus 90050, 5600 PB EINDHOVEN, Bldg. VB,  
Tel. +31 40 27 82785, Fax. +31 40 27 88399

**New Zealand:** 2 Wagener Place, C.P.O. Box 1041, AUCKLAND,  
Tel. +64 9 849 4160, Fax. +64 9 849 7811

**Norway:** Box 1, Manglerud 0612, OSLO,  
Tel. +47 22 74 8000, Fax. +47 22 74 8341

**Philippines:** Philips Semiconductors Philippines Inc.,  
106 Valero St. Salcedo Village, P.O. Box 2108 MCC, MAKATI,  
Metro MANILA, Tel. +63 2 816 6380, Fax. +63 2 817 3474

**Poland:** Ul. Lukiska 10, PL 04-123 WARSZAWA,  
Tel. +48 22 612 2831, Fax. +48 22 612 2327

**Portugal:** see Spain

**Romania:** see Italy

**Russia:** Philips Russia, Ul. Usatcheva 35A, 119048 MOSCOW,  
Tel. +7 095 755 6918, Fax. +7 095 755 6919

**Singapore:** Lorong 1, Toa Payoh, SINGAPORE 1231,  
Tel. +65 350 2538, Fax. +65 251 6500

**Slovakia:** see Austria

**Slovenia:** see Italy

**South Africa:** S.A. PHILIPS Pty Ltd., 195-215 Main Road Martindale,  
2092 JOHANNESBURG, P.O. Box 7430 Johannesburg 2000,  
Tel. +27 11 470 5911, Fax. +27 11 470 5494

**South America:** Al. Vicente Pinzon, 173, 6th floor,  
04547-130 SÃO PAULO, SP, Brazil,  
Tel. +55 11 821 2333, Fax. +55 11 821 2382

**Spain:** Balmes 22, 08007 BARCELONA,  
Tel. +34 3 301 6312, Fax. +34 3 301 4107

**Sweden:** Kottbygatan 7, Akalla, S-16485 STOCKHOLM,  
Tel. +46 8 632 2000, Fax. +46 8 632 2745

**Switzerland:** Allmendstrasse 140, CH-8027 ZÜRICH,  
Tel. +41 1 488 2686, Fax. +41 1 488 3263

**Taiwan:** Philips Semiconductors, 6F, No. 96, Chien Kuo N. Rd., Sec. 1,  
TAIPEI, Taiwan Tel. +886 2 2134 2865, Fax. +886 2 2134 2874

**Thailand:** PHILIPS ELECTRONICS (THAILAND) Ltd.,  
209/2 Sanpavuth-Bangna Road Prakanong, BANGKOK 10260,  
Tel. +66 2 745 4090, Fax. +66 2 398 0793

**Turkey:** Talatpasa Cad. No. 5, 80640 GÜLTEPE/ISTANBUL,  
Tel. +90 212 279 2770, Fax. +90 212 282 6707

**Ukraine:** PHILIPS UKRAINE, 4 Patrice Lumumba str., Building B, Floor 7,  
252042 KIEV, Tel. +380 44 264 2776, Fax. +380 44 268 0461

**United Kingdom:** Philips Semiconductors Ltd., 276 Bath Road, Hayes,  
MIDDLESEX UB3 5BX, Tel. +44 181 730 5000, Fax. +44 181 754 8421

**United States:** 811 East Arques Avenue, SUNNYVALE, CA 94088-3409,  
Tel. +1 800 234 7381

**Uruguay:** see South America

**Vietnam:** see Singapore

**Yugoslavia:** PHILIPS, Trg N. Pasica 5/v, 11000 BEOGRAD,  
Tel. +381 11 625 344, Fax. +381 11 635 777

**For all other countries apply to:** Philips Semiconductors,  
International Marketing & Sales Communications, Building BE-p, P.O. Box 218,  
5600 MD EINDHOVEN, The Netherlands, Fax. +31 40 27 24825

**Internet:** <http://www.semiconductors.philips.com>

© Philips Electronics N.V. 1998

SCA57

All rights are reserved. Reproduction in whole or in part is prohibited without the prior written consent of the copyright owner.

The information presented in this document does not form part of any quotation or contract, is believed to be accurate and reliable and may be changed without notice. No liability will be accepted by the publisher for any consequence of its use. Publication thereof does not convey nor imply any license under patent- or other industrial or intellectual property rights.

Printed in The Netherlands

125108/00/03/pp16

Date of release: 1998 Jan 29

Document order number: 9397 750 03239

*Let's make things better.*

**Philips**  
Semiconductors



**PHILIPS**